



By Appointment to
Her Majesty The Queen
Manufacturer and Supplier
of Secondary Glazing
Selectaglaze Ltd.
St Albans

Uniclass L413

CI/SfB

| (31.4) | Hh4 |

March 2017

Secondary Glazing Product and Performance Guide



selectaglaze™

Founded in 1966, Selectaglaze is the UK's leading specialist in secondary glazing.

All products are bespoke and designed to meet the individual needs of each project. Manufacture takes place at the company's St Albans factory; installations are carried out by in-house teams, or through a network of regional partners.

The secondary glazing product range is the result of over 50 years of research and development. Independently tested and certified, they will meet exacting requirements for acoustic and thermal performance, environmental control, protection against intruders, bomb blast, ballistic attack and fire. The extensive range offers the designer a solution to suit most types of building and window styles across all market sectors.

Quality of product and service is extremely important; as testament, the company was pleased to be granted a Royal Warrant in 2004.



What is 'secondary glazing?'

Secondary glazing is a fully independent internal window, fitted on the room-side of the existing (primary) window, to form a double window or 'double glazing'. The gap between the primary and secondary windows can vary, depending on how or why the additional glazing is to be installed, e.g. the gap is normally greater when noise insulation is the priority.

Installing secondary glazing will significantly improve a building's environment by providing improved thermal performance, noise reduction, as well as enhanced security. Integral seals are effective in minimising the ingress of dust and dirt, thereby helping to preserve clean areas.

Major benefits

Warmer – improved thermal insulation by reducing heat loss and excluding draughts. This means lower energy bills, a smaller carbon footprint and higher rated Energy Performance Certificates (EPCs) or BREEAM ratings.

Quieter – more effective noise insulation leads to quieter, less stressful environments and reduced sleep disturbance. Secondary glazing can be a very effective way of meeting exacting noise criteria demanded by planning authorities.

Safer – provides an additional security barrier that will deter intruders, offer protection against blast and even against fire arms or fire.

Accreditations and affiliations

Selectaglaze is certified to Quality Management Standard ISO 9001 and regularly undergoes audits through the Loss Prevention Certification Board to demonstrate continued compliance.

The company also has accreditations covering Health and Safety, Security, Training and is a member of a number of Trade Associations.

Typical applications

Secondary glazing is specified in a wide variety of buildings including those used as hospitals, hotels, offices, museums, homes, schools and colleges, churches, theatres, pubs and secure establishments.

Its discreet, sympathetic and neat unobtrusive design makes it the ideal solution to preserve and retain the character of older, more traditional buildings and satisfies the requirements of all the UK heritage and conservation bodies for use in Listed buildings. It is increasingly specified for new build projects on brownfield sites in need of higher levels of noise insulation and for more modern buildings wishing to improve thermal performance by creating triple glazing.



Anatomy of Selectaglaze secondary glazing



Framing

Sections are designed and extruded from aluminium alloy. This strong, lightweight material can be formed to create the slender, complex shapes needed to accommodate seals, fixings and specialist hardware.



Forming

Selected sections can be curved and shaped to match the primary window.



Finishes

Framing is available in two types of finish:

- 1. Polyester powder paint coated** Standard colour is HIPCA White semi-gloss; other RAL colours in flat, metallic or textured finishes, to order, including wood grain effect.
- 2. Anodised** In natural silver, bronze and a limited range of other colours.

Both paint and anodised finishes are very durable with long life expectancy and minimal maintenance.



Gaskets

Glazing is held in position by specialist gaskets or bonding tapes. They are available in black and white.



Weatherseals

Sliding units are fitted with twin silicone-treated, grey polypropylene pile seals.

Hinging units are fitted with high performance Q-Lon seals (in white or black). This material has excellent 'memory' and will retain its original shape for years, maintaining optimum sealing and acoustic performance.

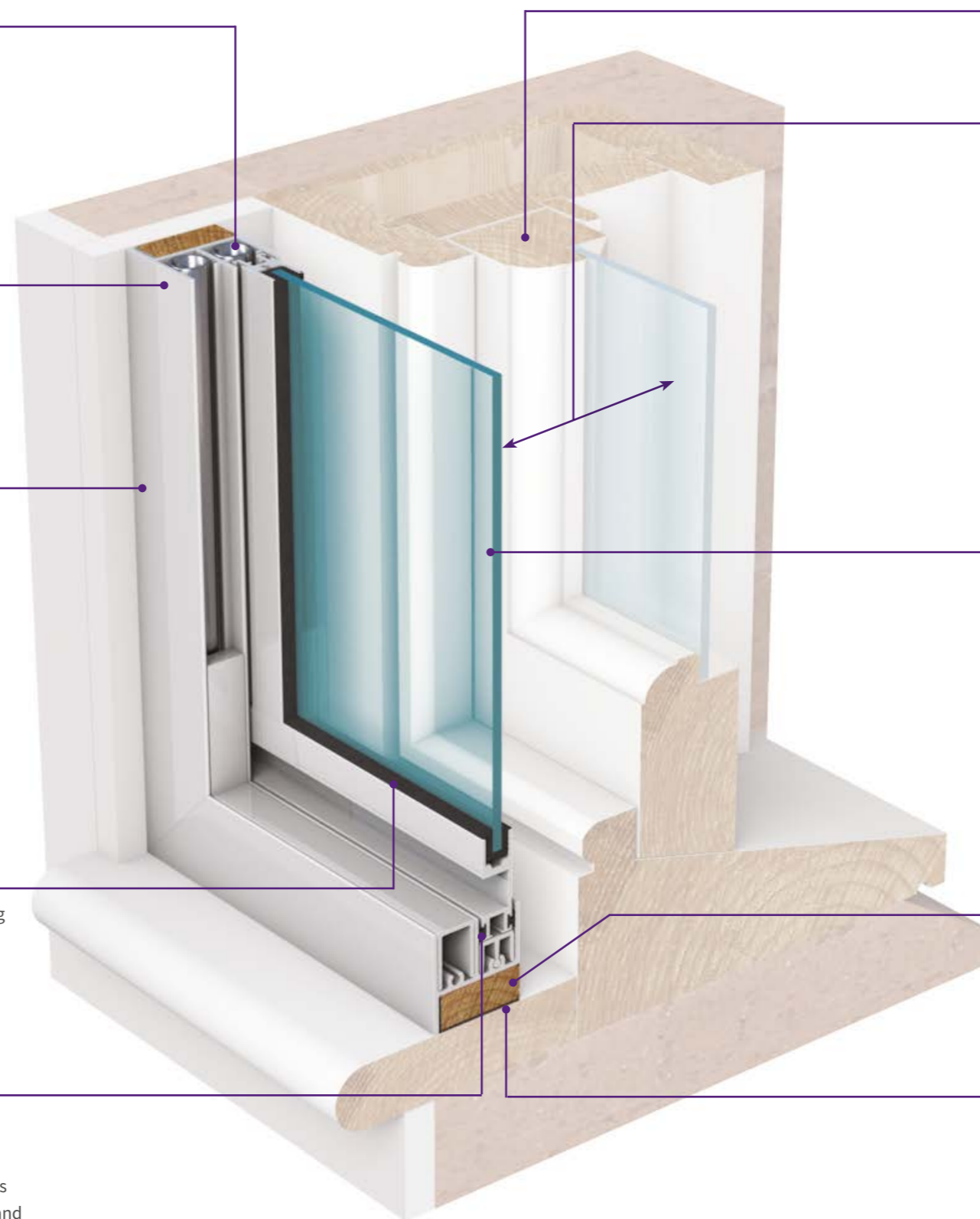

Primary window

The outer or existing window frame.

Cavity

The gap between the primary and secondary windows.

Glazing

Glazing complies with BS 6262: 2005, the Code of Practice for glazing in buildings, and meets the requirements of Building Regulations Parts N1 and N2.

Glass thickness varies from 4mm to 28mm depending on the product and application.

Other glazing options include:

Enhanced thermal

- low emissivity (hardcoat)
- sealed glass unit (various specifications)

Enhanced acoustic

- acoustic laminates

Safety

- toughened
- laminated

Solar control

- body tinted

Privacy

- patterned
- opaque laminate
- screen printed or etched
- switchable glass
- sealed glass unit with integral blind

Clarity

- anti-reflective glass
- low iron glass

Security

- anti-bandit laminates
- polycarbonate sheet
- glass/polycarbonate composites

Grounds and sub-frames

Custom made timber grounds can accommodate splayed or out of shape openings. All timber grounds and sub-frames are made from FSC certified timber products.

Sealants

Timber grounds, sub-frames and aluminium frames are bedded on an acrylic sealant to provide a lasting perimeter seal.

Selectaglaze has a policy of continual product improvement and innovation; therefore the company reserves the right to change product specifications without prior notice. Colours shown in this brochure are as accurate as allowed for by the printing process.

Thermal performance

An independent, correctly installed and sealed secondary window frame will minimise air leakage; it also 'traps' an insulating layer of air that can reduce heat loss by up to 50% using standard glass and 65% with low-E glass.

Furthermore, sealed unit glazing, available with selected systems, creates triple glazing and even higher levels of insulation. The result is a more comfortable living or working environment with reduced energy demand.

Why improve?

The **2008 Climate Change Act** committed the UK to reduce greenhouse gas emissions by 80% against 1990 levels by 2050. Since buildings account for 40% of emissions and 80% of existing stock will still be standing in 2050, retrofit solutions will be essential if the targets are to be met.

Building Regulations Approved Document L: Parts L1B and L2B cover the energy efficiency in buildings undergoing renovation or upgrade. Controlled fittings such as windows must meet strict performance standards, but the regulations acknowledge the sensitivity of working on Listed buildings. Hence, single-glazed windows that are part of the historic fabric of the building can be retained and secondary windows incorporating low-emissivity glass fitted, subject to Listed Building Consent.

Energy Performance Certificates (EPC) are required when a building is constructed, sold or rented to identify its energy performance rating. Low rated buildings may prove more difficult to sell or lease and after April 2018 it will be unlawful to let those with the lowest ratings, F or G. Retrofitted secondary glazing can be an important factor in maintaining the building's use.

BREEAM is the UK's leading assessment method for sustainability in buildings and addresses many issues including energy, health and wellbeing. Secondary glazing can effectively contribute towards a higher rating.



How secondary glazing improves thermal performance

Original window...

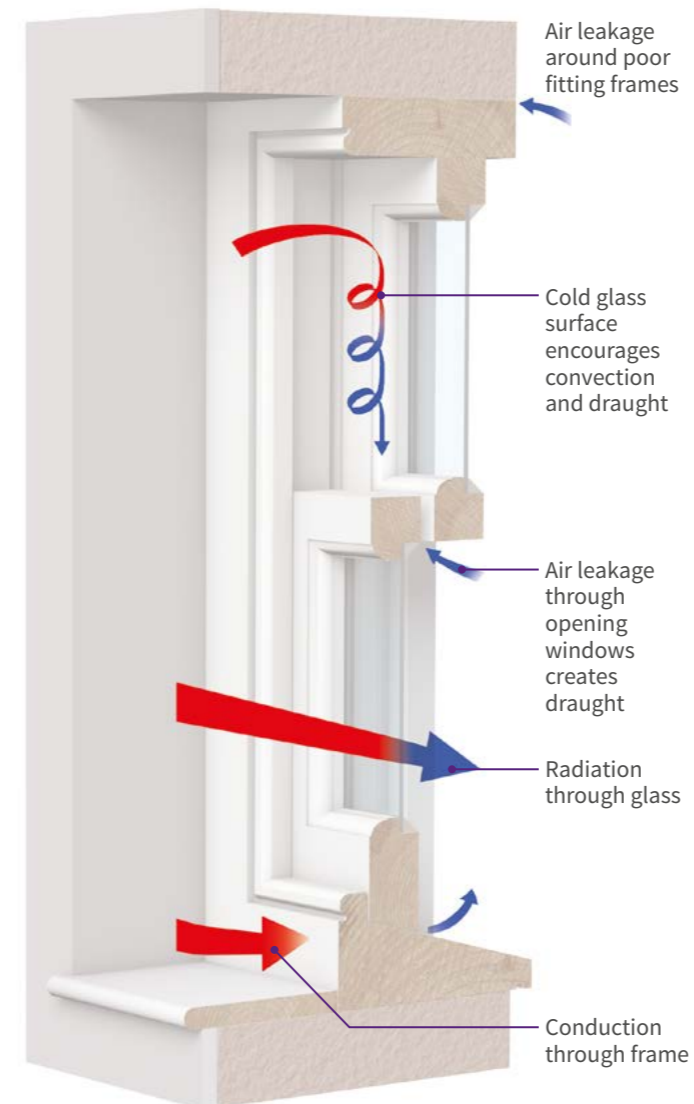

...with secondary glazing

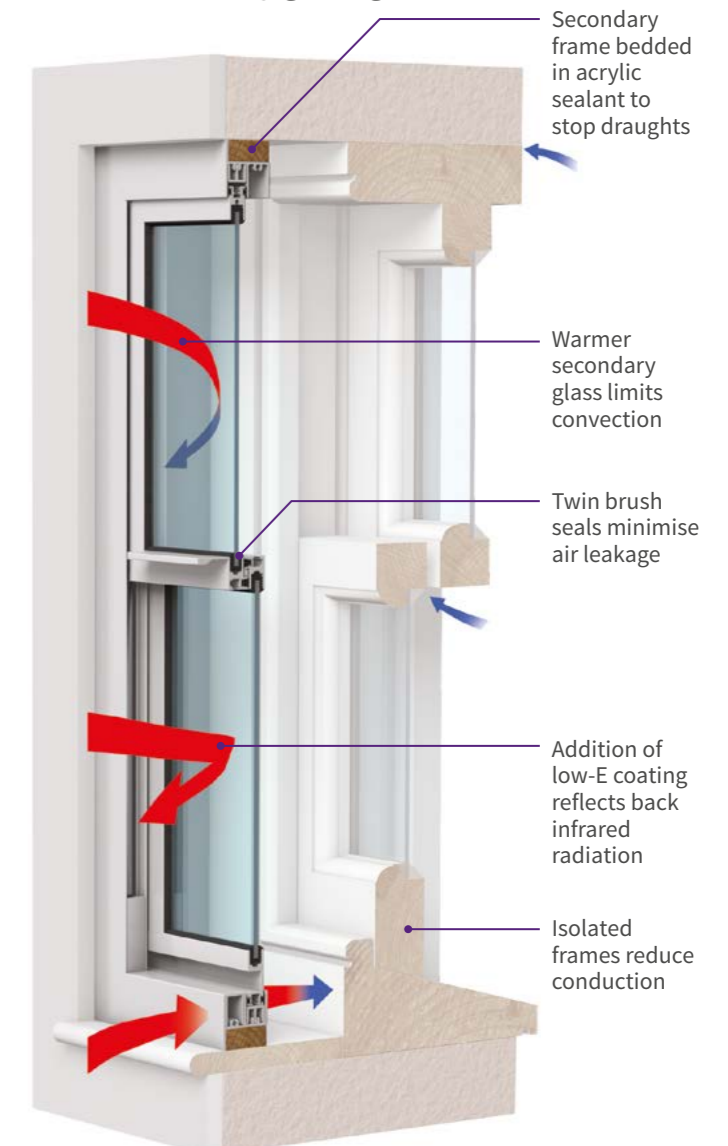

The secondary window traps an insulating mass of air between the inner and outer glass and the resulting warmer surface of the inner glass limits convection currents. Isolated frames are also less conductive and draughts are significantly reduced by efficient seals applied both to the frame and opening panels. If a low-E coating is applied to the inner glass, it will reflect back infrared radiation and so retain energy in the room.

Zero in on U-values

Building Regulations: Approved Document L Requirements

L2A	Non-dwellings - new
L2B	Non-dwellings - existing
L1B	Dwellings - existing
L1A	Dwellings - new

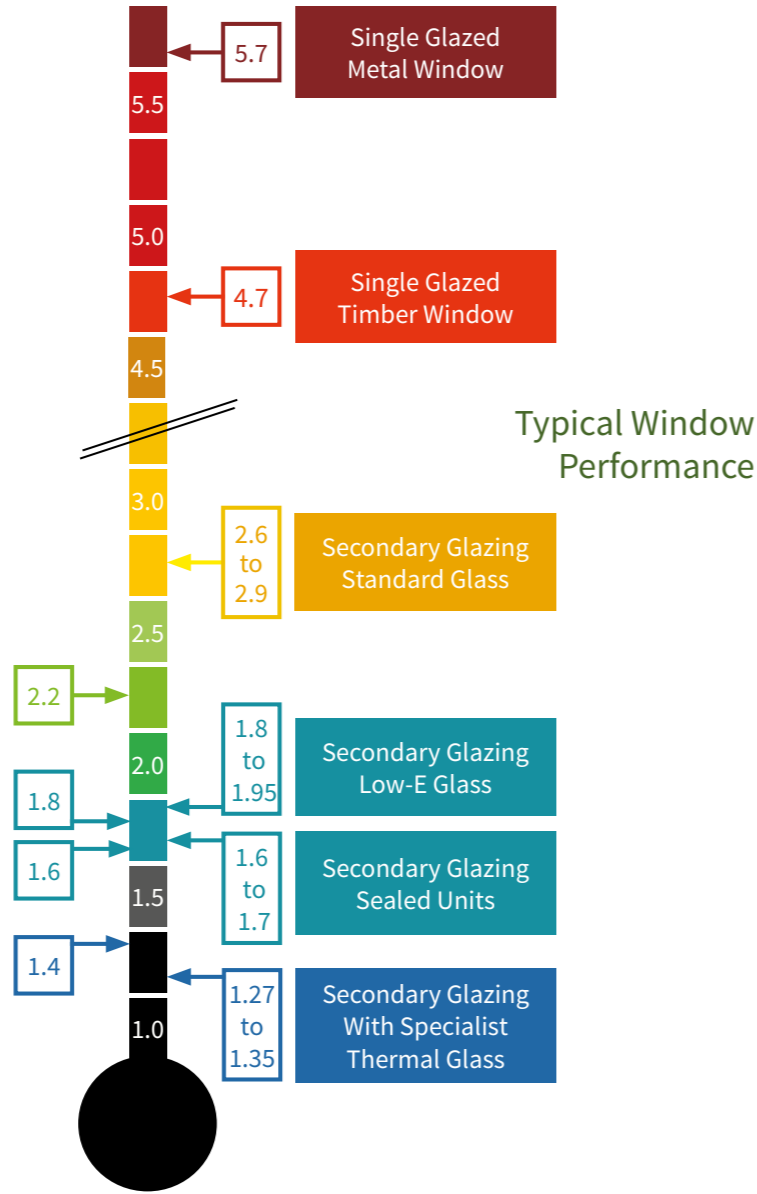

Notes

U-value is a measure of heat loss expressed in W/m²K and shows the rate of heat loss per m² of material when the temperature difference between inside and outside is one degree. The lower the rating the better the insulation. As secondary glazing is used in combination with primary windows, U-values are normally calculated using modelling software.

Low-E glass has a hard metallic coating on the surface facing the cavity, which significantly helps with heat containment. There is a small reduction in light transmittance and a slight roughness on the coated surface, which can lead to light scatter and may be visible as a haze when the sun is strong and low. This is not a defect in the glass. The coated surface should be cleaned occasionally with a lint free cloth and clean soapy water. Abrasive materials must not be used.

Solar gain is the warming effect of the sun which can be a benefit in the winter but a problem in the summer months. The g-value measures the amount of solar energy transmitted through a material with 0 representing no transmittance and 1 the maximum. A standard glass achieves 0.8 but when lower levels are needed, for example on a south facing façade, a specialist window film can be applied to the primary window.

Testing and certification

The thermal performance of the product range has been assessed against both timber and metal primary windows by the Centre for Windows and Cladding Technology (CWCT).

Please visit our website for performance figures. Summary tables are on page 49.

Case study: John Street, London

An historic Listed Georgian townhouse in London's Bloomsbury has been transformed into a comfortable, peaceful and energy efficient home that approaches Passivhaus EnerPHit standards.

This was achieved using modern insulation techniques including an advanced secondary glazing system from Selectaglaze that markedly improved the performance of the traditional, single glazed sash windows.

The client wished for a home that used as little energy as possible and offered the most comfortable environment. Prewett Bizley architects took on the challenge of convincing conservation officers that a Grade II Listed building could be successfully fitted with a host of energy saving measures whilst respecting all the historic features.

The large single glazed sash windows were a challenge as they represented a significant proportion of wall area and could not be replaced. The answer was secondary glazing; but the extremely high levels of insulation required, the aesthetics and the need for working shutters in some rooms demanded a bespoke solution.

Selectaglaze originally proposed a totally new design but coincidentally was both developing a new sash window design and trialling Pilkington's Spacia thin vacuum units which have a centre pane U-value of 1.0. The resulting Series 25 window proved perfect

for the project as it offered high sealing efficiency, a very low U-value and a discreet frame with a specially developed slide catch that allowed shutters to fully close. The house now has airtightness close to 1 air change/hour at test pressure which demonstrates that the secondary glazing is performing very well.

The complexity of the project and the time needed to obtain consents meant that part of the building had to be occupied before the secondary glazing was fitted. As a result, the owner experienced the change in comfort levels offered by the original window and with the secondary glazing in place. The difference was remarkable and what was also evident was the almost complete removal of road noise. This had not originally been regarded as a significant problem but the absence of noise certainly added to the comfort.



Acoustic performance

A well-sealed secondary window, with a cavity of at least 100mm can provide noise reduction in excess of 45dB. Combined with double glazed windows, up to 56dB is achievable. The result is a more peaceful living or working environment.

Why improve?

Most traditional single glazed windows with poorly sealed frames offer little defence against unwelcome noise and even modern double glazed windows fare little better against high sound levels.

Noise is unwanted sound and a form of pollution that can be detrimental to health.

A significant reduction in noise level will:

- create a quieter less stressful environment
- reduce sleep disturbance
- help improve concentration and productivity
- protect hearing

World Health Organisation 'Guidelines for Community Noise' and **BS 8233** set out guidelines for acceptable sound levels in a range of environments. An acceptable sound pressure level (SPL) is 30 to 35dBA for a bedroom, 35 to 50dBA for a classroom or meeting room and 45 to 50dBA for a typical open office. Traffic noise close to the façade of a building on fairly busy roads will be 70 to 80dBA and hence sound reductions in the range 30 to 50dBA are required.

National Planning Policy Framework: 2012 assesses the impact of noise in new developments. Brownfield sites will often be located in areas with very challenging noise levels and window designs involving an additional secondary window to produce acoustic triple glazing can be pivotal in meeting acoustic requirements.

Building Bulletin 93, Acoustic Design of Schools Feb 2015 sets out minimum standards for ambient noise levels in school rooms.



How secondary glazing improves acoustic performance

Original window...

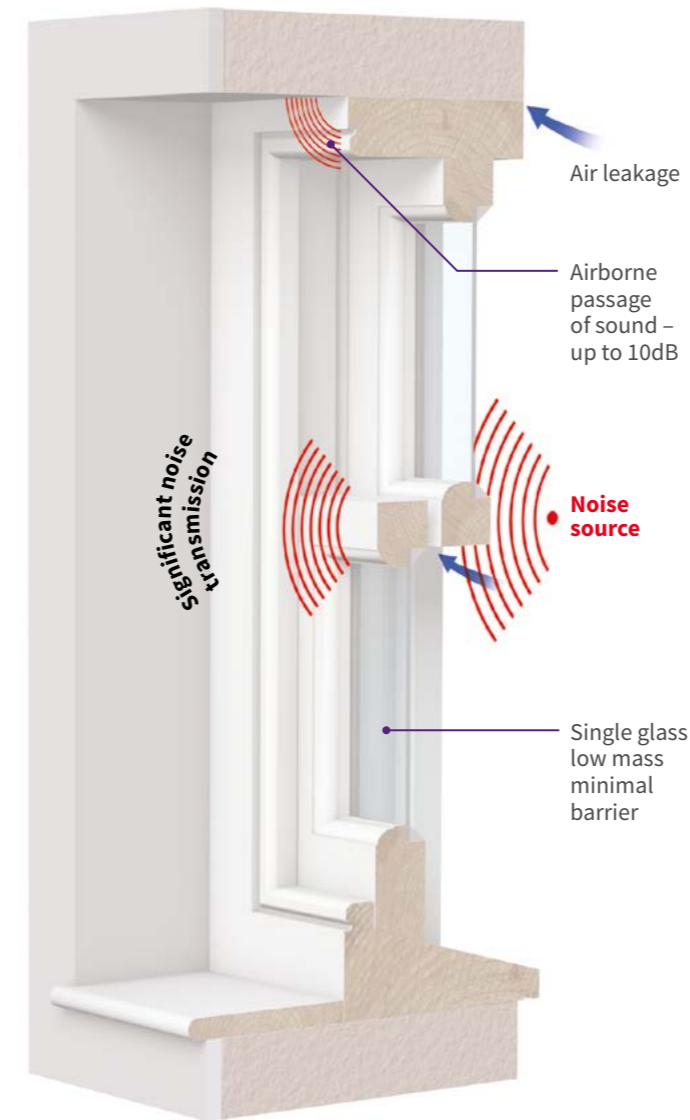

...with secondary glazing

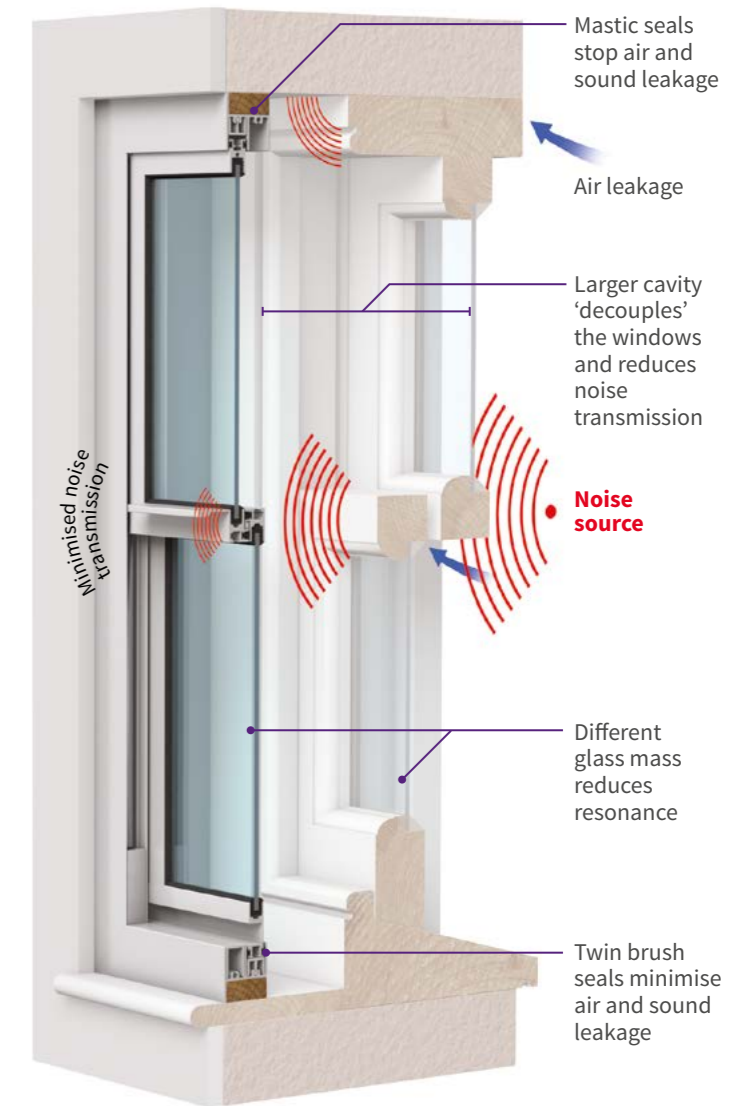

Sound is transmitted through a window by direct vibration of the glass. The larger air space created by secondary glazing decouples the movement of the inner and outer glass, which means they act as separate barriers, thereby reducing resonance.

By contrast, a typical sealed glass unit, where the two panes of glass are rigidly connected and have a minimal cavity, performs little better than a single pane.

Airborne sound is also a major problem with ill-fitting windows – a 1% gap in the total window area can reduce sound insulation by as much as 10dB. A purpose-made secondary window seals the whole of the external window with frames bedded on an acrylic sealant and opening panels fitted with high performance seals.

Optimising performance

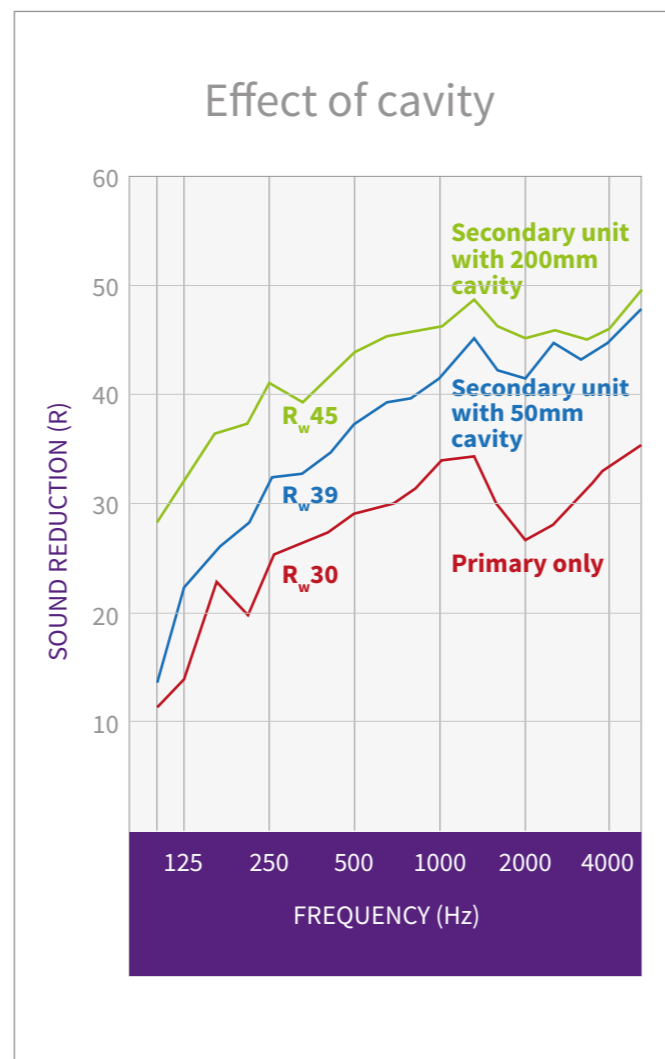
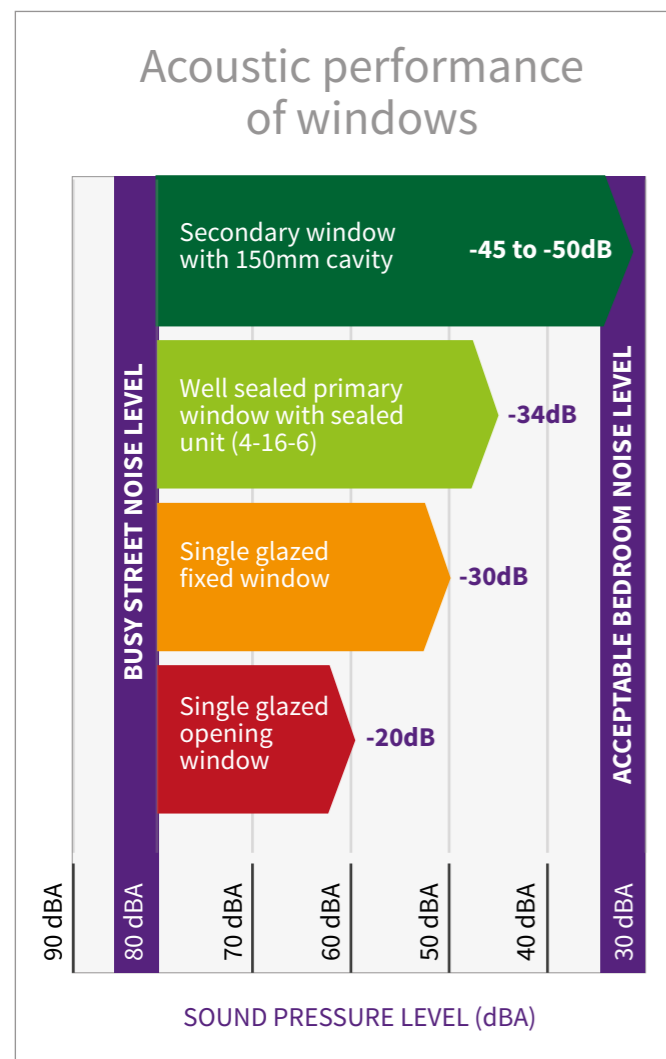

Notes

Sound is measured as a pressure and expressed in dB (decibels) which is a logarithmic scale. 0dB represents the threshold of hearing and 120 dB the onset of pain. To the human ear a change of 3dB is just about noticeable whereas an increase of 10dB approximates to a doubling of loudness.

Cavity is the space between the existing primary windows and the secondary glazing. Performance improves as the cavity increases with an optimum of about 200mm.

Glass type and thickness have a direct impact on performance. Thicker glass has greater mass, so will provide better acoustic results. Ideally the secondary glass should be of different thickness to the primary window glass to avoid sympathetic resonance which will increase noise transmission. Acoustic laminate glass helps improve performance at higher frequencies.

Reveal linings are acoustic absorbent lining materials which can be fitted to the reveals, normally at the head and jambs. These raise insulation levels by 1 to 2dB and are used when external sound levels are very high.

Testing and certification

The product range has been tested against single glazed primary windows with 50mm, 100mm, 150mm and 200mm cavities. Testing was carried out by Taylor Woodrow Technology in accordance with Standard BS EN ISO 140-3: 1995 'Laboratory measurement of air-borne sound insulation of building elements'. Results were reviewed and interpolated by Hann Tucker Associates.

Please visit our website for performance figures. Summary tables are on page 50.

Case study: Ham Yard Hotel, London

Located in one of the most vibrant and bustling districts in Central London, lies the stunning Ham Yard Hotel.

Built on a plot that has been vacant for a number of years, the site has a creative past. During the 1920s Ham Yard was home to the Hambone Club for writers and musicians. During the 1940s it became a regular paid jazz club for London musicians called Club Eleven. During WWII the site saw serious damage through bombings and the area was never redeveloped.

Many plans were put forward over the years to develop the site, but all were rejected until, finally permission was granted for Firmdale Hotels to redevelop the area. They created 91 individually designed hotel bedrooms and 24 apartments, along with a 1950's style bowling alley, theatre and restaurant. However, building a hotel in the centre of an area with such vibrant night life does come with its drawbacks.

Although new double glazed windows were installed throughout, the hotel still suffered from high external noise levels. Firmdale Hotels approached Selectaglaze to help deliver a solution with their bespoke secondary glazing systems.

Three different unit styles were used, one of which was the Series 80 horizontal slider, typically used for larger windows as it can hold up to 12mm thick glass. Acoustic laminated glass was used, which absorbed sound from outside, to



assist in creating a more peaceful and relaxing environment – as well as a good night's sleep.

A total of 37 openings were treated with the secondary glazing being finished in a dark grey colour to match the existing primary windows, making them as inconspicuous as possible.

As testament to the detailed planning throughout the design and build phases, the hotel also gained a BREEAM 'Excellent' rating.



Security performance

Windows are often 'soft targets' for intruders and if subjected to a blast attack, flying shards of glass will be an extreme hazard. Retrofitted secondary glazing provides a discreet, extra protective barrier; being a reversible adaptation it is ideal for Listed properties.

Some systems also aid containment in locations such as laboratories and secure health facilities, or offer protection against fire arms or spread of flame. The result is safer, more secure environments be it at home, business premises or public institutions.

Why improve?

Peace of mind. Burglary can be a very disturbing and disruptive experience. Electronic security will warn but not resist and even a simple secondary window with locks and enhanced glazing will be a deterrent to an opportunistic attack.

Duty of care. Those responsible for buildings that could suffer the effects of a bomb blast or an outside disturbance as well as physical attack by intruders will have a duty of care to employees and visitors.

Insurance risk. Poor protection of a building could result in higher insurance premiums or removal of cover. In particular, museums with high value exhibits must meet strict security guidelines to benefit from a Government indemnity scheme.

Regulation. Building Regulations Approved Document Q covers unauthorised access in dwellings. Laboratories are subject to HSE standards and facilities considered to be part of Critical National Infrastructure are covered by Government security standards.



Intruder protection

Frames, locks and fixings must resist driving force and levering; if the glass is vulnerable it must be difficult to break. The selection of frame and glass will be dependent on the risk.

Risk Level	Risk description	Treatment	Standard	Note
Low	Opportunistic attack	Standard frames with simple locks and toughened or laminated glass	None	
Medium	More determined attack using stealth to avoid noise that could attract attention	Robust frames with multipoint locking to opening panels and a choice of anti-bandit laminated glass	Secured by Design	1
High	A planned and determined attack on both the frame and glass	Enhanced frames with multipoint locking to opening panels and glazed with a specialist secure glass	LPS 1175	2

Note 1: Secured by Design is a Police Crime Prevention Initiative. Products successfully tested to PAS 24 are awarded a 'Police Preferred Specification' and also comply with Building Regulation Part Q: Security – Dwellings. PAS 24: 2016 security test simulates forced entry by stealth and does not involve glass breakage which would draw attention to the intruder. However, SBD guidance requires 'at risk' windows to meet glazing standard EN 356 Level P1A (6.8mm laminate) but higher strength laminated glass can be fitted in areas of increased risk.

Note 2: LPS1175 is a standard developed by the Loss Prevention Certification Board to test elements of the building façade such as doors, windows, shutters and grilles but is also applied to gates, fencing and security enclosures. There are eight test levels each with a defined set of tools and attack time becoming more severe at each higher level. The tests are extremely rigorous and involve every part of the window including glass. Certified products are listed on www.redbooklive.com and twice yearly audits ensure continued compliance. Secondary windows are tested stand-alone and hence the existing primary window could increase resistance. Secondary windows are available up to Level 3.



Blast mitigation

A vehicle bomb will shatter glass at a distance of more than 100m and glass shards will cause injury to people and damage to sensitive equipment. Frames, locks and glass must absorb and spread the blast load. Laminated glass is specified as it is made from sheets of glass bonded to a polyvinyl butyral (pvb) interlayer. Under load the pvb stretches and holds the glass so that damaging shards are not formed. The selection of frame and glass will be dependent on the risk.

Risk Level	Risk description	Treatment	Standard	Note
Low	The building is not a direct target but its commercial or public use may impose a 'duty of care'	Standard frames with simple locks and 6.8mm laminated glass	ISO 16933 Level EXV45	3
Medium	The building is close to more sensitive buildings and hence could be more vulnerable	Robust frames, multipoint locking to opening panels, 6.8mm laminated glass with deeper edge cover and stronger structure fixings	ISO 16933 Level EXV33	3
High	The building is a potential direct target on account of its use or ownership and is likely to have a number of protective strategies	Enhanced frames designed to absorb higher blast loads, secure multi-point locking to opening panels, laminated glass with minimum 1.5mm pvb interlayer (7.5mm, 9.5mm, 11.5mm) and secure structure fixings	ISO 16933 Level EXV25	3

Note 3: ISO 16933 is a test to determine the air blast resistance of security glazing using a range of charges at different distances. 100kg TNT equivalent is generally used to simulate a small vehicle bomb. The target can be positioned at a number of distances, or stand-offs, starting at 45m. Products tested at this level are classified EXV45 together with a hazard rating based on the level of damage. EXV45 (a) denotes 'no break' in the glass whereas (d) denotes very low hazard and (e) low hazard. Other stand-offs are 33m, 25m, 19m, 15m, 12m and 10m. A rating below EXV25 is not normally required but selected Selectaglaze systems can protect to EXV15(d).



Ballistic attack

Traditionally, ballistic protection has been provided by multiple layers of glass laminated together with pvb interlayers. The resultant material is both thick and heavy and needs large supporting frames. Thinner and lighter panes can be produced by laminating layers of glass with polycarbonate. This allows the design of smaller more easily handled frames, making it the preferred material for retrofitted secondary glazing.

To ensure continuous protection, Selectaglaze ballistic windows consist of demountable fixed panels which are attached by removable fixings to permanently anchored frames. This design allows for planned maintenance.



Fire protection

Secondary glazing may be required to windows that need fire resistance on account of proximity to a fire escape or an adjacent building. A fully developed fire achieves temperatures that will melt aluminium so frames must be specially adapted. The inclusion of Pilkington Pyrodur™ glass in conjunction with intumescent seals and fire rated mastics provides half hour integrity protection.



Testing and certification

Physical Intrusion

Physical tests are conducted to the following standards:

- LPS 1175: Issue 7. Specification for testing and classifying the burglary resistance of building components, strong-points and security enclosures
- PAS 24:2012. Enhanced security performance requirements for doorsets and windows in the UK

Note : PAS 24 has been developed as a standard for primary windows and doors but secondary windows successfully tested in accordance with the requirements are accepted as a Police Preferred Specification under the Secured by Design initiative.

Selectaglaze products are tested at the Building Research Establishment

Blast

Blast testing is carried out in accordance with:

- ISO 16933:2007. Glass in Building – Explosion Resistant Security Glazing – Test and Classification for Arena Air Blast Loading.

Selectaglaze products are tested at arena trials conducted by Comblast at the DNV-GL's Spadeadam test centre.

Ballistic tests

Ballistic tests are conducted to standard:

- EN 1522 /1523, 'Windows, doors, shutters and blinds – Bullet resistance –Requirements, Classification and Test method'.

The standard has eight levels of certification covering handguns, rifles and shotguns.

Selectaglaze product is tested by Wiltshire Ballistic Services.

Fire tests

Fire tests are conducted to standard:

- BS EN 1363-1, 1364-1, 'Fire resistance tests. General requirements/fire resistance tests for non-load bearing elements. Walls'.

Selectaglaze product is tested by Chiltern International Fire.

Please visit our website for performance figures. Summary tables are on page 51.

Case study: Banqueting House, London

The stunning Grade I Listed Banqueting House, managed and cared for by Historic Royal Palaces, was designed by Inigo Jones between 1619 and 1622 after its predecessor was destroyed by fire. It has stood witness to many historical events, most famously, King Charles I was executed, in Cromwell's time, outside the building in 1649 on a temporary scaffold specially built for the occasion.

Banqueting House still contains the only surviving in-situ ceiling painting series by Sir Peter Paul Rubens, a breath-taking canvas masterpiece commissioned by Charles I to commemorate his father's life, King James I.

The security window installations were part of the first phase of works to repair and restore this building. Security was a key concern when planning the works, as was reducing noise from the busy Whitehall outside. The design replaced the blast net curtains and allows daylight once again to flood into the Main Hall, as well as providing a significant level of noise insulation to ensure visitors peace and tranquillity when viewing the Rubens.

Selectaglaze was approached to provide a fitting bespoke solution that not only offered protection to the large windows, but was a discreet and unobtrusive window treatment, to blend in with the historic interior.





Selectaglaze has products certified to the requirement, but they had never been specified to these sizes (the Main Hall window openings were 3.6m high and 2.0m wide). Blast testing was carried out on the largest ever single casement to be tested in the UK. The results were a success and planning for the installation began.

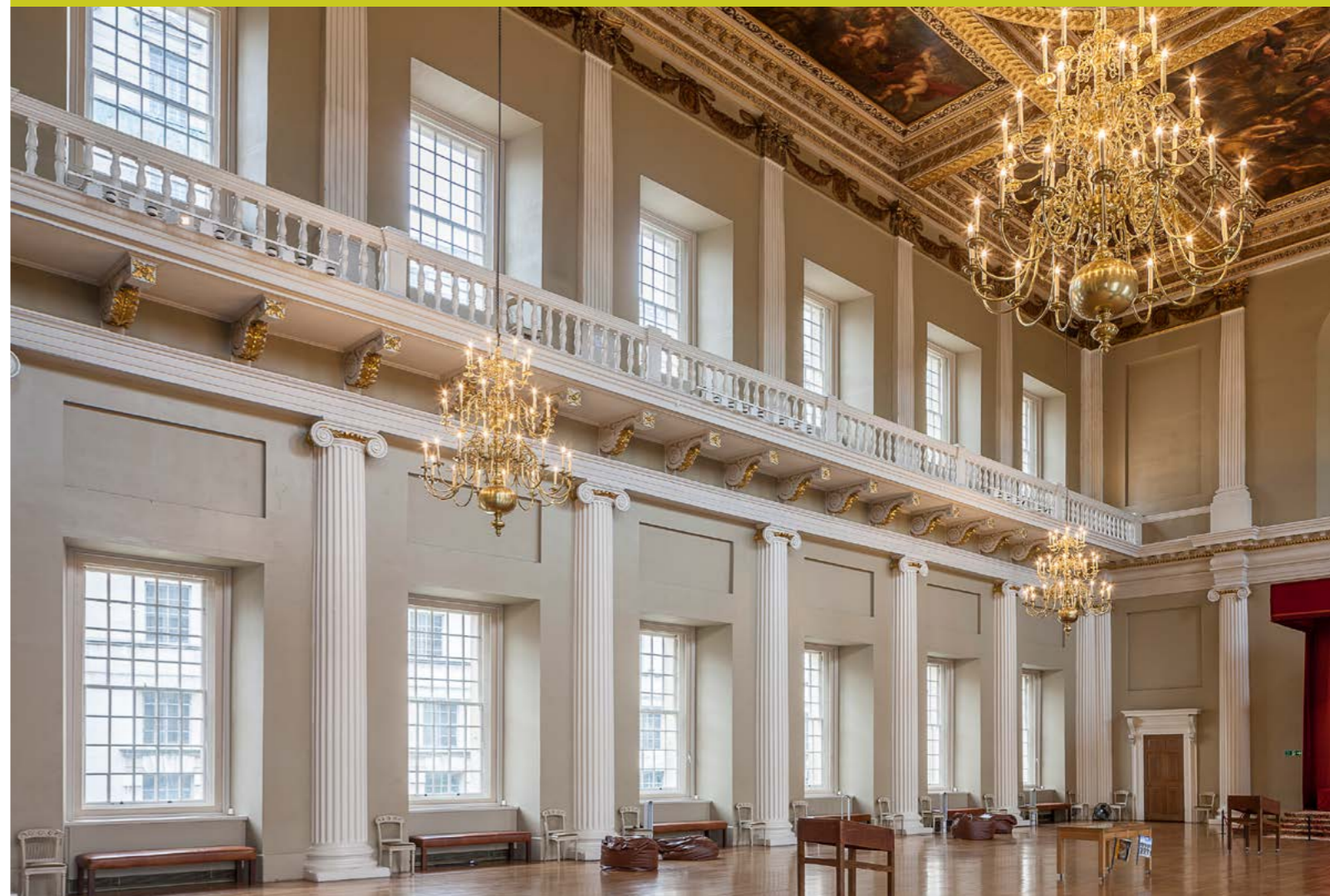

Installing the units provided a challenge as half the openings were at upper gallery level 10m above the main floor. The gallery could not be loaded. Working very closely with Gardner & Theobald, structural engineers Hockley & Dawson and Royal Warrant holding scaffolders Allen and Foxworthy, a careful method of installation was devised involving a columnar scaffolding design complete with lifting apparatus to each opening. In all, 39 units were installed.

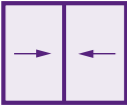



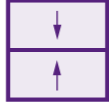

Product selector

HORIZONTAL SLIDER (HS)	
	
	
RECOMMENDED APPLICATION	
Ideal where easy access is a priority; sashes slide within the frame so no problems with blinds or curtains; large and ribbon windows can be accommodated by linking units.	
SERIES 10	Page 20
Slimline versatile framing system in 2, 3 or 4 pane options that provides easy access to the outer window.	
SERIES 15	Page 21
Mid-range discrete framing system in 2 or 3 pane options for larger windows; also accepts thicker glass to achieve higher noise insulation.	
SERIES 80	Page 22
Heavy duty framing system in 2, 3 or 4 pane options for very large windows. 2 and 3 pane versions accredited to Secured by Design.	
SERIES 85	Page 23
High security framing system in 2 panes only, providing significant levels of intruder resistance and blast mitigation.	

VERTICAL SLIDER (VS)	
	
	
RECOMMENDED APPLICATION	
Ideal for treating sash windows; operates with spring balances which support the weight of the sash in all positions.	
SERIES 20	Page 24
Slimline framing system ideal for treating traditional sash windows often found in heritage properties.	
SERIES 25	Page 25
Mid-range framing system with higher capacity balances for larger windows, supports thicker glass to achieve higher noise insulation; accredited to Secured by Design.	
SERIES 90	Page 26
Heavy duty framing system with specialist balances that allows very large sash windows to be treated and is accredited to Secured by Design.	
SERIES 95	Page 27
High security framing system capable of providing significant levels of intruder resistance and blast mitigation.	
SERIES 60	Page 28
Specialist framing system allowing individual panes to tilt inwards on safety stays to assist with cleaning.	

HINGED CASEMENT (HC)	
	
	
RECOMMENDED APPLICATION	
Offers full and easy access to an outer window or door. Neat and unobtrusive with single casements having no mullions or transoms to impede the view.	
SERIES 45	Page 30
Slimline framing system suitable for treating many types of window and standard sized doors. When fitted to traditional sash windows new sight lines are avoided. Single casements accredited to Secured by Design.	
SERIES 41	Page 31
Heavy duty framing system suitable for large windows and doors; supports thicker glass for higher noise insulation and both single and double casements accredited to Secured by Design.	
SERIES 50	Page 32
High security framing system capable of treating very large windows and doors; provides significant levels of intruder resistance and blast mitigation.	
SERIES 47	Page 33
Specialist framing system with very slim profiles to allow installation within the staff bead of smaller, traditional sash windows.	

LIFT-OUT (LO)	
	
	
RECOMMENDED APPLICATION	
Offers a practical solution for treating windows which are rarely opened, but require occasional access for cleaning or maintenance.	
SERIES 30	Page 34
Slimline framing system usually applied to smaller windows.	
SERIES 45	Page 35
Slimline framing using Series 45 hinged profiles without hinges. Suitable for larger and curved windows.	
SERIES 41	Page 36
Heavy duty framing using Series 41 hinged profiles without hinges. Suitable for very large and curved windows; supports thicker glass for higher noise insulation.	

FIXED LIGHT (FL)	
	
	
RECOMMENDED APPLICATION	
Generally used in combination with other products as over lights or side lights and particularly useful for arched windows.	
SERIES 46	Page 38
Slimline framing system suitable for smaller windows. Can be shaped and curved.	
SERIES 42	Page 39
Heavy duty framing system accepting thicker glass for higher noise insulation. Can be shaped and curved and is accredited to Secured by Design.	
SERIES 40	Page 40
Specialist framing system offering 30 minutes fire integrity.	

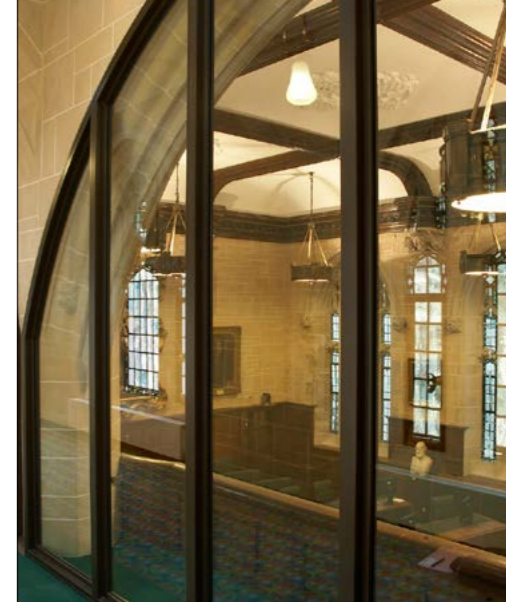
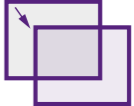
DEMOUNTABLE FIXED LIGHT (DFL)	
	
	
RECOMMENDED APPLICATION	
Provides secure glazing to vulnerable windows and vision panels to Control Rooms and Laboratories.	
SERIES 43	Page 42
Heavy duty framing system offering intruder resistance and blast mitigation. Minimal section size suited to heritage buildings.	
SERIES 55	Page 43
High security framing system providing significant intruder resistance, blast mitigation and protection against hand guns.	



A slim and versatile horizontal sliding system that provides easy access to the external window for ventilation.

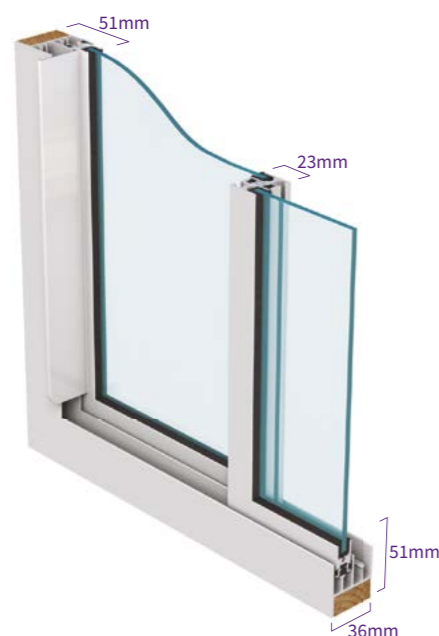

FEATURES

- Available with 2, 3 or 4 sliding sashes (panels)
- Sashes slide on glide pads (ref R1)
- Full height, integral projecting handle (ref H1)
- 23mm wide interlock stile
- Twin brush seals ensure high sealing efficiency
- Fixings concealed within the frame – trims not required
- Sashes are removable for maintenance and cleaning
- Frames may be linked with a colour matched aluminium transom/mullion section

DIMENSIONS

Recommended maximum frame

Format	Height (mm)	Width (mm)
2 PANES	2200	2800
3 PANES	2200	4200
4 PANES	2200	4900

Maximum sash (h)2200mm x (w)1400mm, minimum sash (h)350mm x (w)250mm

Overall dimensions are subject to a maximum sash weight of 40kg and a risk assessment covering window location and type of end user

Sash height to width ratio should not normally exceed 4:1

FRAME COLOUR

Stock finish is white HIPCA 9910 semi-gloss
Any standard powder paint, wood grain finish or anodised finish to order

OPTIONS

Glazing	4mm to 6.8mm
Frames	Heavy duty interlock stile Heavy duty box interlock stile Low profile running track to clear inward opening windows (ref F2) Triple track allowing 3 sashes to stack at one end (ref F3) Curved jambs- minimum radius 450mm
Hardware	R2 Medium duty ball-race with nylon tyre
Ironmongery (see page 44/45)	H3 Recessed finger pull for contra-sliding L1 Shoot-bolt L2 Lockable fitch catch L4 Plunge lock L13 Sliding latch L28 'U' channel track restrictor



A mid-range horizontal sliding system with more robust but still slender framing sections that allow discreet treatment of larger windows. It can support thicker glass when higher levels of noise insulation are needed.

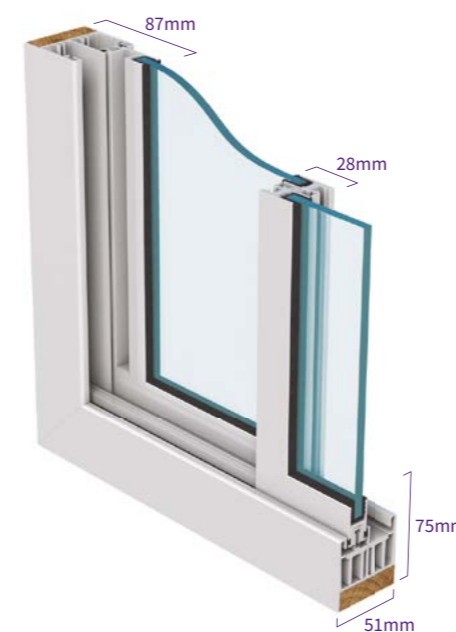

FEATURES

- Available with 2 or 3 sliding sashes (panels)
- Sashes slide on stainless steel ball races (ref R3)
- Integral full height recessed finger pulls allow sashes to contra slide
- 28mm wide interlock stile
- Twin brush seals ensure high sealing efficiency
- Fixings concealed within the frame – trims not required
- Sashes are removable for maintenance and cleaning
- Frames may be linked with a colour matched aluminium transom/mullion section

DIMENSIONS

Recommended maximum frame

Format	Height (mm)	Width (mm)
2 PANES	2400	3000
3 PANES	2400	4500

Maximum sash (h)2400mm x (w)1500mm, minimum sash (h)350mm x (w)250mm

Overall dimensions are subject to a maximum sash weight of 60kg and a risk assessment covering window location and type of end user.

Sash height to width ratio should not normally exceed 4:1

FRAME COLOUR

Stock finish is white HIPCA 9910 semi-gloss
Any standard powder paint, wood grain finish or anodised finish to order

OPTIONS

Glazing	4mm to 8.8mm
Frames	Heavy duty interlock stile
Ironmongery (see page 44/45)	L2 Lockable fitch catch L24 Sliding latch

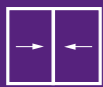

A heavy duty horizontal sliding system designed to treat large windows and doors. Thicker glass specifications will provide higher levels of noise insulation and when fitted with a secure lock option the system achieves Secured by Design accreditation for 2 & 3 panel designs.



FEATURES

- Available with 2, 3 or 4 sliding sashes (panels)
- Sashes run on stainless steel ball races (ref R3)
- Moulded pull handles (ref H4)
- 40mm wide interlock stile
- Twin brush seals ensure high sealing efficiency
- Fixings concealed within the frame - trims not required
- Sashes are removable for maintenance and cleaning
- Frames may be linked with a colour matched aluminium transom/mullion section

DIMENSIONS

Recommended maximum frame

Format	Height (mm)	Width (mm)
2 PANES	2800	3600
3 PANES	2800	5400
4 PANES	2800	5900

Maximum sash (h)2800mm x (w)1800mm, minimum sash (h)400mm x (w) 400mm

Overall dimensions are subject to a maximum sash weight of 90kg and a risk assessment covering window location and type of end user

Sash height to width ratio should not normally exceed 4.5:1

FRAME COLOUR

Stock finish is white HIPCA 9910 semi-gloss
Any standard powder paint, wood grain finish or anodised finish to order

OPTIONS

Glazing	6mm to 12.8mm
Frames	Curved jambs – minimum radius 500mm
Ironmongery	H3 Recessed finger pull for contra-sliding
(see page 44/45)	L21/H23 Multipoint lock
	L22/H23 Multipoint lock (SBD/EXV33)

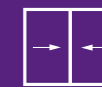

A high security 2 pane horizontal sliding unit capable of providing blast mitigation to level EXV25 of ISO 16933 and intruder resistance to levels SR1 or SR2 of standard LPS1175, equivalent to protection offered by strong bars and grilles.

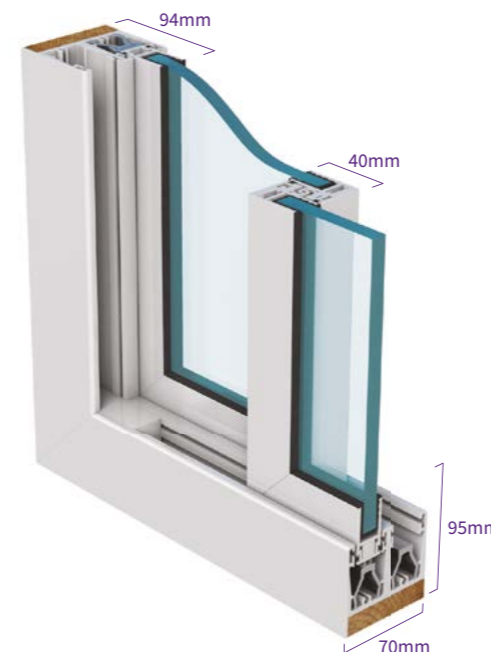

FEATURES

- Sashes run on stainless steel ball races (ref R3)
- Anti-lift and anti-jemmy features
- Finger pull handles (ref H10)
- High security multipoint locking (ref L23/H24)
- Twin brush seals ensure high sealing efficiency
- Fixings concealed within the frame – trims not required
- Sashes are removable by specialists for maintenance and cleaning

DIMENSIONS

Recommended maximum frame

Format	Height (mm)	Width (mm)
2 PANES	2600	3000

Maximum sash (h)2600mm x (w)1500mm, minimum sash (h)650mm x (w)500mm

Overall dimensions are subject to a maximum sash weight of 90kg
Sash height to width ratio should not normally exceed 4.5:1

FRAME COLOUR

Stock finish is white HIPCA 9910 semi-gloss
Any standard powder paint, wood grain finish or anodised finish to order

OPTIONS

Glazing	9.5mm to 12.04mm
----------------	------------------



A slim section vertical sliding unit suitable for treating traditional sash windows. Spring balances fully support the sliding sashes in all positions.



FEATURES

- Recessed finger pull on lower sash allows contra-sliding to assist with cleaning
- 23mm interlock stile with projecting finger pull
- Twin brush seals ensure high sealing efficiency
- Fixings concealed within the frame - trims not required
- Frames may be linked with a colour matched aluminium transom/mullion section

DIMENSIONS

Recommended maximum frame

Format	Height (mm)	Width (mm)
2 PANES	3000	1400

Maximum sash (h)1500mm x (w)1400mm, minimum sash (h)300mm x (w)350mm

Overall dimensions are subject to a maximum sash weight of 20kg

Sash height to width ratio should not normally exceed 1:3

A minimum frame to frame gap of 75mm is recommended for access to the outer window

FRAME COLOUR

Stock finish is white HIPCA 9910 semi-gloss
Any standard powder paint, wood grain finish or anodised finish to order

OPTIONS

Glazing	4mm to 6.8mm
Frames	Heavy duty box interlock stile Curved heads - minimum radius 450mm
Ironmongery (see page 44/45)	H3 Recessed finger pull to upper sash H17 Cranked 'D' handle to upper sash L2 Lockable fitch catch L4 Plunge lock L13 Sliding latch

A mid-range vertical sliding unit with higher capacity spring balances that allow treatment of larger windows and also support thicker glass when increased levels of noise insulation are needed. With secure locking it is accredited to Secured by Design.



FEATURES

- Recessed finger lift on lower sash allows contra-sliding to assist with cleaning
- 28mm wide interlock stile with projecting finger pull
- Twin brush seals ensure high sealing efficiency
- Fixings concealed within the frame - trims not required
- Frames may be linked with a colour matched aluminium transom/mullion section

DIMENSIONS

Recommended maximum frame

Format	Height (mm)	Width (mm)
2 PANES	3000	1600

Maximum sash (h)1500mm x (w)1600mm, minimum sash (h)400mm x (w)400mm

Overall dimensions are subject to a maximum sash weight of 31kg, or 50kg by special request, and a minimum of 4.5kg

Sash height to width ratio should not normally exceed 1:3

A minimum frame to frame gap of 75mm is recommended for access to the outer window

FRAME COLOUR

Stock finish is white HIPCA 9910 semi-gloss
Any standard powder paint, wood grain finish or anodised finish to order

OPTIONS

Glazing	4mm to 8.8mm
Ironmongery (see page 44/45)	H3 Recessed finger pull to upper sash H17 Cranked 'D' handle to upper sash L2 Lockable fitch catch L3 SBD Secure lockable fitch catch (2 per unit) L24 Sliding latch



A heavy duty vertical sliding unit supported on specialist balances allowing treatment of very large sash windows. Thicker glass offers higher levels of noise insulation and with secure locking it is accredited to Secured by Design.

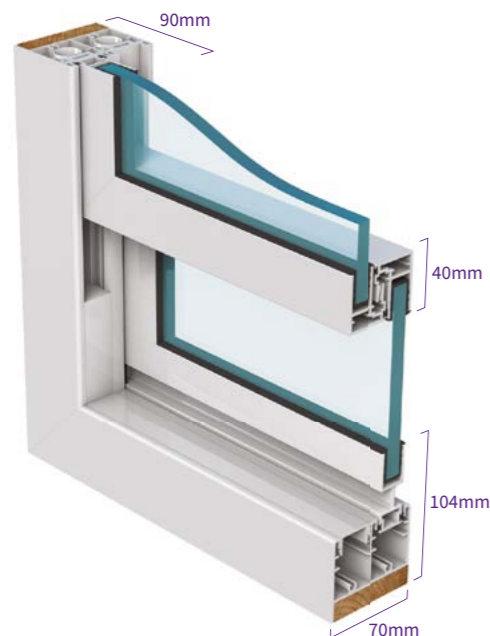

FEATURES

- Recessed finger pull on lower sash allows contra-sliding to assist with cleaning
- Moulded pull handles to upper sash (ref H4)
- 40mm wide interlock stile
- Twin brush seals ensure high sealing efficiency
- Fixings concealed within the frame - trims not required
- Sashes are removable by specialists to allow maintenance
- Frames may be linked with a colour matched aluminium transom/mullion section

DIMENSIONS

Recommended maximum frame

Format	Height (mm)	Width (mm)
2 PANES	3600	2000

Maximum sash (h)1800mm x (w)2000mm, minimum sash (h)400mm x (w)400mm

Overall dimensions are subject to a maximum sash weight of 65kg and minimum of 4kg

Sash height to width ratio should not normally exceed 1:3

A minimum frame to frame gap of 75mm is recommended for access to the outer window

FRAME COLOUR

Stock finish is white HIPCA 9910 semi-gloss
Any standard powder paint, wood grain finish or anodised finish to order

OPTIONS

Glazing	6mm to 12.8mm
Frames	Curved heads – minimum radius 700mm
Ironmongery	H17 Cranked 'D' handle to upper sash
(see page 44/45)	L2 Lockable fitch catch
	L21/H23 Multipoint lock
	L22/H23 Multipoint lock (SBD/EXV33)

A high security vertical sliding unit supported on specialist balances that is capable of providing blast mitigation to level EXV25 of ISO 16933 and intruder resistance to levels SR1 or SR2 of standard LPS1175, equivalent to protection offered by strong bars and grilles.

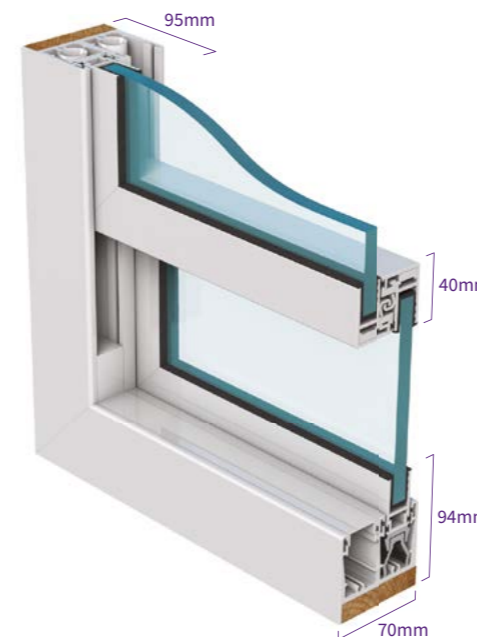

FEATURES

- Anti-jemmy features
- High security multipoint locking (ref L23/H24)
- Finger pull handles to lower sash (ref H10)
- Moulded pull handles to upper sash (ref H4)
- Twin brush seals ensure high sealing efficiency
- Fixings concealed within the frame - trims not required
- Sashes are removable by specialists for maintenance

DIMENSIONS

Recommended maximum frame

Format	Height (mm)	Width (mm)
2 PANES	3000	2000

Maximum sash (h)1500mm x (w)2000mm, minimum sash (h)500mm x (w)650mm

Overall dimensions are subject to a maximum sash weight of 65kg

Sash height to width ratio should not normally exceed 1:3

A minimum frame to frame gap of 75mm is recommended for access to the outer window

FRAME COLOUR

Stock finish is white HIPCA 9910 semi-gloss
Any standard powder paint, wood grain finish or anodised finish to order

OPTIONS

Glazing	9.5mm to 12.04mm
----------------	------------------



A vertical sliding unit with panels that can tilt-in; useful when windows have unequal pane sizes or if frames need to be fitted close together. Sashes are supported on spring balances and have stay arms to allow safe tilting for cleaning or access.

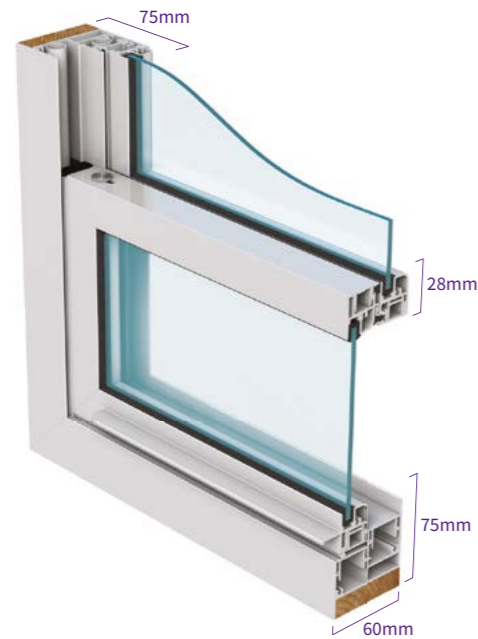

FEATURES

- Sprung release catches allow sashes to tilt in
- Stainless steel stay arms safely hold the sash in the open position
- Friction brake mechanism prevents the sashes sliding in the tilt position
- Integral projecting finger pull to lower sash
- Twin seals ensure good sealing efficiency
- Fixings concealed within the frame - trims not required
- Frames may be linked with a colour matched aluminium transom/mullion section

DIMENSIONS

Recommended maximum frame

Format	Height (mm)	Width (mm)
2 PANES	3000	1500

Maximum sash (h)1500mm x (w)1500mm, minimum sash (h)400mm x (w)400mm

Overall dimensions are subject to a maximum sash weight of 20kg
Sash height to width ratio should not normally exceed 1:3

FRAME COLOUR

Stock finish is white HIPCA 9910 semi-gloss
Any standard powder paint, wood grain finish or anodised finish to order

OPTIONS

Glazing	4mm to 6.8mm
Ironmongery	H17 Cranked 'D' handle to upper sash
(see page 44/45)	L2 Lockable fitch catch

Case study: Lighthouse Building

Once a building at risk, and on the Historic England's register deemed unsafe for use, the Grade II Listed Lighthouse building has been carefully renovated into a quieter and warmer office and retail space with the help of Selectaglaze.

Adjacent to Kings Cross and round the corner from St. Pancras, sits the iconic Flat-Iron Lighthouse Building. No one knows when it was built exactly, but there are indications it was somewhere between 1875 - 1884; the purpose of the building is also unknown. Some speculate the building once sold oysters, others say the Lighthouse may have been used to spot fires or even a camera obscura; it still remains a mystery today.

Having lain derelict for over 20 years, UK Real Estate took on the enormous task of restoring and revitalising the iconic building for its new purpose as office and retail space and appointed Balfour Beatty as its main contractor. The project wasn't without its challenges, with two underground tunnels running beneath; the building's restoration had to be carefully managed, including tackling the issues of noise and vibrations.

The solution to the extensive noise and vibration issues was to isolate all internal fixtures and fittings by inserting elastomeric bearing pads at all points of contact with the external structure. Secondary glazing was an intrinsic component of this solution as a fully independent internal window system allows the full sealing of the new internal envelope.



Selectaglaze recommended the use of 8mm toughened glass, glazed to Series 25 and Series 90 vertical sliders and Series 41 lift out units, designed to suit the style and sightlines of the primary window. In total Selectaglaze installed 83 units all of which were bespoke to each opening.

When there is a cavity of at least 100mm between the primary and secondary glazing a reduction of 45dB is achievable. An additional benefit of secondary glazing is thermal retention, with the use of high performance twin seals, it virtually eradicates unwanted drafts and a U-value of 1.8 is possible.





A versatile hinged system with slim sections and flush hinges suitable for treating windows and standard sized doors. Single casements with a secure lock option achieve Secured by Design accreditation.



FEATURES

- Available in single side hung, top hung, bottom hung, double casement and stable door designs
- Double casement and stable door provide full access
- Strong, purpose designed flush hinges colour matched to frame
- Colour matched non-locking handle (ref H7)
- Multipoint locking (ref L20)
- 90° restrictor stay to side hung
- Ratchet stay to top hung (ref L26)
- Twin compression seals ensure high sealing efficiency
- Fixings concealed within the frame - trims not required
- Frames may be linked with a colour matched aluminium transom/mullion section

DIMENSIONS

Recommended maximum frame

Format	Height (mm)	Width (mm)
SINGLE SIDE HUNG	2200	1300
TOP/BOTTOM HUNG	1300	1300
DOUBLE CASEMENT	2200	2600
STABLE DOOR	2200	1100

Minimum side hung sash (h)700mm x (w)450mm

Minimum top/bottom hung sash (h)400mm x (w)500mm

FRAME COLOUR

Stock finish is white HIPCA 9910 semi-gloss
Any standard powder paint, wood grain finish or anodised finish to order

OPTIONS

Glazing	4mm to 6.8mm
Frames	Curved head or jamb – minimum radius 450mm 'No threshold' cill (ref F12)
Ironmongery (see page 44/45)	H6 Locking slimline handle H8 Locking handle H9 Rosette -square drive with removable key H12, H15, H16 Feature handles H18 Vivo low-profile handle H21 Flush lock with cover disc H22 Flush lock with security cover plate L7 Spring catch L15 Multipoint locking (SBD/EXV33) L29 Sprung restrictor stay



A versatile heavy duty hinged system suitable for treating large windows and doors. A range of glazing beads support thicker glass, standard sealed units and sealed units with integral blinds. Single and double casements with a secure lock option achieve Secured by Design accreditation.



FEATURES

- Available in single side hung, top hung, bottom hung, double casement and stable door designs
- Double casement and stable door provide full access
- Strong, purpose designed flush hinges colour matched to frame
- Colour matched non-locking handle (ref H7)
- Multipoint locking (ref L20)
- 90° restrictor stay to side hung
- Ratchet stay to top hung (ref L26)
- Twin compression seals ensure high sealing efficiency
- Fixings concealed within the frame - trims not required
- Frames may be linked with a colour matched aluminium transom/mullion section

DIMENSIONS

Recommended maximum frame

Format	Height (mm)	Width (mm)
SINGLE SIDE HUNG	2700	1500
TOP/BOTTOM HUNG	1500	1500
DOUBLE CASEMENT	2700	3000
STABLE DOOR	2700	1350

Minimum side hung sash (h)700mm x (w)450mm

Minimum top/bottom hung sash (h)400mm x (w)500mm

Size limits vary according to glass thickness

FRAME COLOUR

Stock finish is white HIPCA 9910 semi-gloss
Any standard powder paint, wood grain finish or anodised finish to order

OPTIONS

Glazing	6mm to 28mm -single glass and sealed units
Frames	Curved head or jamb – minimum radius 500mm Curved on plan – minimum radius 1800mm 'No threshold' cill (ref F12)
Ironmongery (see page 44/45)	H6 Locking slimline handle H8 Locking handle H9 Rosette - square drive with removable key H12, H15, H16 Feature handles H18 Vivo low-profile handle H21 Flush lock with cover disc H22 Flush lock with security cover plate L7 Spring catch L15 Multipoint locking single casement (SBD/EXV33) L25 Multipoint locking double casement (SBD) L29 Sprung restrictor stay



A strong casement system suitable for very large windows needing thicker glass or for high security applications. Offers blast mitigation to level EXV15 of ISO 16933 and intruder resistance to levels SR1 or SR2 of standard LPS1175, equivalent to bars and grilles.



FEATURES

- Available in single side hung, top hung, bottom hung and double casement designs
- Double casement provides full access
- Strong, purpose designed flush hinges colour matched to frame
- 30mm glazing rebate
- Multipoint locking
- Colour matched non-locking handle (ref H7) or locking handle (ref H8) for security specifications
- 90° restrictor stay to non-security side hung
- Ratchet stay to non-security top hung (ref L26)
- Twin compression seals
- Fixings concealed within the frame - trims not required
- Frames may be linked with a colour matched transom/mullion section

DIMENSIONS

Recommended maximum frame

Format	Height (mm)	Width (mm)
SINGLE SIDE HUNG	3600	1800
TOP/BOTTOM HUNG	1800	1800
DOUBLE CASEMENT	3600	3000

Minimum side hung sash (h)700mm x (w)450mm

Minimum top/bottom hung sash (h)400mm x (w)500mm

Size limits vary according to security option and glass thickness

FRAME COLOUR

Stock finish is white HIPCA 9910 semi-gloss
Any standard powder paint, wood grain finish or anodised finish to order

OPTIONS

Glazing	6mm to 24mm – single glass and sealed units
Frames	Curved head or jamb – minimum radius 1000mm
Ironmongery	Security
(see page 44/45)	L15 Multipoint lock (SBD/EXV33)
	L17 Multipoint lock (LPS1175/EXV25)
	L18 Multipoint lock (EXV15)
	Non Security
	H8 Locking handle
	H9 Rosette -square drive with removable key
	H12, H15, H16 Feature handles
	H18 Vivo low-profile handle
	H21 Flush lock with cover disc
	L20 Multipoint lock
	L29 Sprung restrictor stay



An extremely slim hinged casement unit that will fit within the staff bead position of a traditional sash window and is designed to provide high levels of thermal insulation with minimal intrusion.



FEATURES

- Strong, purpose designed flush hinges colour matched to frame
- 4mm toughened, low-E glass
- Multipoint latch (ref L16)
- Removable colour matched operating catch (ref H19)
- 90° restrictor stay
- Twin compression seals ensure high sealing efficiency
- Fixings are concealed within the frame

DIMENSIONS

Recommended maximum frame

Format	Height (mm)	Width (mm)
SINGLE SIDE HUNG	2000	1000

Minimum sash (h)400mm x (w)300mm

FRAME COLOUR

Stock finish is white HIPCA 9910 semi-gloss
Any standard powder paint, wood grain finish or anodised finish to order

OPTIONS

No options available



A slim lift-out system applied to windows that are rarely used but which need access for cleaning or maintenance.



FEATURES

- Available in vertical lift out (LO) or side to side shuffle out (SO) options
- Integral finger pull (ref H1)
- Fixings concealed within the frame - trims not required
- Frames may be linked with a colour matched aluminium transom/mullion section

DIMENSIONS

Recommended maximum frame

Format	Height (mm)	Width (mm)
LIFT OUT	1400	1000
SHUFFLE OUT	1700	600

Minimum vertical lift (h)300mm x (w)350mm
Minimum shuffle out (h)350mm x (w)250mm

Overall dimensions are subject to a risk assessment covering sash weight, window location and type of end user

FRAME COLOUR

Stock finish is white HIPCA 9910 semi-gloss
Any standard powder paint, wood grain finish or anodised finish to order

OPTIONS

Glazing	4mm to 6.8mm
Ironmongery	H3 Recessed finger pull
(see page 44/45)	L11 Cam lock
	L12 Screw lock



A version of the slim Series 45 casement unit without hinges that is suited to shaped and circular windows or openings with restricted access needing a removable panel.



FEATURES

- **Rectangular frame and Curved frame >500mm radius**
- Twin compression seals
- Fixings are concealed within the frame - trims not required
- Multipoint locking (L20)
- Rectangular: Flush lock with cover disc (H21)
- Curved: Rosette square drive with removable key (H9)
- **Curved frame <500mm radius**
- Spring catch (L7)

DIMENSIONS

Recommended maximum frame

Format	Height (mm)	Width (mm)
LIFT OUT	2200	1000

Minimum sash (h)700mm x (w)450mm

Overall dimensions are subject to a risk assessment covering sash weight, window location and type of end user

FRAME COLOUR

Stock finish is white HIPCA 9910 semi-gloss
Any standard powder paint, wood grain finish or anodised finish to order

OPTIONS

Glazing	4mm to 6.8mm
Frames	Curved head, jamb or full circle - minimum radius 450mm
Ironmongery	Rectangular frame
(see page 44/45)	• Choice of handles



A version of the Series 41 casement unit without hinges that is suited to larger shaped and circular windows or openings with restricted access needing a removable panel. A range of glazing beads allows the use of thicker glass and sealed units.



FEATURES

Rectangular frame and Curved frame >500mm radius

- Twin compression seals
- Fixings are concealed within the frame - trims not required
- Multipoint locking (L20)
- Rectangular: Flush lock with cover disc (H21)
- Curved: Rosette square drive with removable key (H9)

Curved frame <500mm radius

- Spring catch (L7)

DIMENSIONS

Recommended maximum frame

Format	Height (mm)	Width (mm)
LIFT OUT	2400	1200

Minimum sash (h)700mm x (w)450mm

Overall dimensions are subject to a risk assessment covering sash weight, window location and type of end user

FRAME COLOUR

Stock finish is white HIPCA 9910 semi-gloss

Any standard powder paint, wood grain finish or anodised finish to order

OPTIONS

Glazing	6mm to 28mm – single glass and sealed units
Frames	Curved head, jamb or full circle – minimum radius 500mm Curved on plan – minimum radius 1800mm
Ironmongery (see page 44/45)	Rectangular frame • Choice of handles

Case study: St Georges Church

St Georges church in Tufnell Park dates back to 1861 based on a medieval church in Salonica. It was bought by a Protestant evangelical church organisation 'House on the Rock', which completely renovated it and renamed it 'The Rock Tower'.

Not only a place of worship, it also provides a multi-functional centre for the wider community being used for live music events and theatrical productions. Therefore acoustic insulation for noise containment was paramount.

The majority of the windows were gothic arched headed stone mullion with stained glass. The windows to the Nave, measuring 4.5m high x 2m wide, some being 11m from floor level, required shaped units for the heads with either side hung casements or vertical sliding units below for ease of access and maintenance.

A mezzanine floor was added to provide a seating balcony which dissected many of the windows needing secondary glazing. Selectaglaze treated a total of 60 windows, using Series 40, 41 and 45 side hung casements, all glazed with 6.4mm laminated safety glass.



A very slim fixed frame unit normally used in combination with other window styles which can be shaped and curved to a full circle and achieves Secured by Design accreditation.



FEATURES

- Concealed room side fixing channel
- Rectangular frames may be linked with a colour matched aluminium transom/mullion section

DIMENSIONS

Recommended maximum frame

Format	Height (mm)	Width (mm)
FIXED PANE	2200	1400

Minimum (h)300mm x (w)300mm

Fixed panels used on their own should be subject to a risk assessment covering means of escape and condensation management

FRAME COLOUR

Stock finish is white HIPCA 9910 semi-gloss
Any standard powder paint, wood grain finish or anodised finish to order

OPTIONS

Glazing	4mm to 6.8mm
Frames	Curved head, jamb or full circle – minimum radius 250mm

A heavy duty fixed frame unit capable of providing blast mitigation to level EXV25 of ISO 16933 and intruder resistance to levels SR1 or SR2 of standard LPS1175, equivalent to bars and grilles. The frame can be shaped or curved to a full circle.

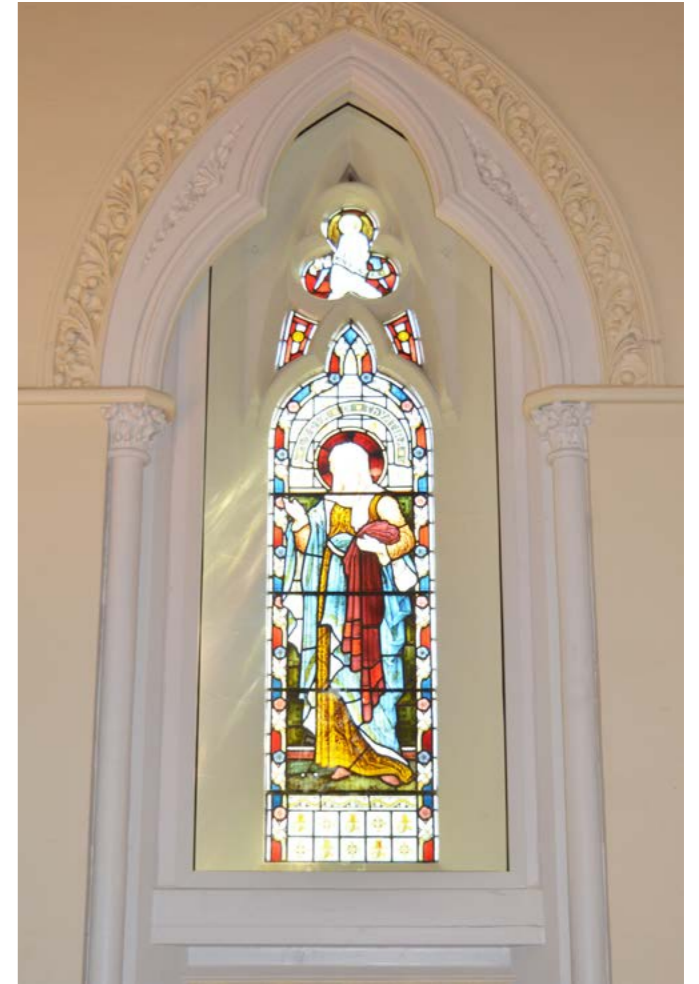

FEATURES

- 20mm glass edge cover
- Concealed room side fixing channel
- Rectangular frames may be linked with a colour matched aluminium transom/mullion section

DIMENSIONS

Recommended maximum frame

Format	Height (mm)	Width (mm)
FIXED PANE	3000	2000

Minimum (h)300mm x (w)300mm

Fixed panels used on their own should be subject to a risk assessment covering means of escape and condensation management

FRAME COLOUR

Stock finish is white HIPCA 9910 semi-gloss
Any standard powder paint, wood grain finish or anodised finish to order

OPTIONS

Glazing	6mm to 12.04mm
Frames	Curved head, jamb or full circle – minimum radius 500mm

A beaded fixed frame system offering 30 minute fire integrity protection. Also available with a range of glazing beads for non-fire applications such as vision panels and clean room environments.



FEATURES

Fire rated

- European Redwood sub frame with intumescent seals
- 10mm Pilkington Pyrodur™

DIMENSIONS

Recommended maximum frame

Format	Height (mm)	Width (mm)
FIRE	2805	1477
THERMAL/ACOUSTIC	3000	1500

Minimum Fire (h)616mm x (w)284mm

Minimum Thermal/acoustic (h)300mm x (w)300mm

FRAME COLOUR

Stock finish is white HIPCA 9910 semi-gloss

Any standard powder paint, wood grain finish or anodised finish to order

OPTIONS

Glazing

Thermal/acoustic

6mm to 28mm – single glass and sealed units

Case study: The Holburne Museum, Bath

Sir William Holburne (1793–1874), who took part in Trafalgar as a young midshipman, dedicated his adult life to collecting objects of beauty – these were eventually gifted to the city of Bath.

In 1916 the ornate Grade I Listed 18th century Sydney House Hotel was acquired to accommodate the collection and renamed The Holburne Museum.

In 2011, the museum underwent a £11.2m renovation including architect Parry's three-storey glass and ceramic extension designed to provide intimate galleries, archive rooms and visitor café.

The main original part of the building now houses two magnificent galleries, including what was once the hotel's ballroom, now known as 'The Ballroom Gallery', whose central displays include silverware, porcelain and china collections; bronze statuettes and oil paintings hanging alongside the room's monumental windows and floor-to-ceiling balcony doors. With windows to three sides, the ballroom is light and airy, capturing the sun throughout the day, presenting perfect viewing conditions but is potentially detrimental to the sustainability of the room's exhibits. To help alleviate this hazard and to provide much needed added security, main contractor Sir Robert McAlpine consulted Selectaglaze.

To protect the exhibits from the harmful rays of the sun, a single hinged casement to each window incorporating anti-UV glazing was proposed. To provide an acceptable level of security the windows incorporated a multi-point locking system accredited to



'Secured by Design'. Other design considerations included a paint finish to match the surrounding décor and maintenance of clean lines through the use of flush hinges and a flush lock. The finished result is secondary glazing which blends imperceptibly with the ballroom's monumental sash windows with no additional sight lines to mar the spectacular views of this stunning Georgian city.

Additional advantages were gained through the high level of sound insulation afforded by a double window system and the inclusion of a low emissivity coating to the glass which markedly reduces heat loss – an important factor for building owners and managers wishing to reduce energy usage and so manage costs and environmental impacts.





A slim but secure demountable fixed frame unit capable of providing blast mitigation to level EXV25 of ISO 16933 and intruder resistance to levels SR1 or SR2 of standard LPS1175, equivalent to bars and grilles.



FEATURES

- Strong frame section with minimal sightlines
- Glazed panels are attached with machine screws which permits occasional removal for cleaning and maintenance
- 20mm glass edge cover
- Fixings concealed within the frame
- Frames can be coupled vertically or horizontally

DIMENSIONS

Recommended maximum frame

Format	Height (mm)	Width (mm)
FIXED PANE	3000	2000

Minimum (h)300mm x (w)300mm

Overall dimensions are subject to a risk assessment covering sash weight and window location

FRAME COLOUR

Stock finish is white HIPCA 9910 semi-gloss
Any standard powder paint, wood grain finish or anodised finish to order

OPTIONS

Glazing	6mm to 12.04mm
Frames	Curved head or jamb – minimum radius 750mm



A very secure demountable fixed frame unit capable of providing blast mitigation to level EXV15 of ISO 16933 and intruder resistance to levels SR1, SR2 or SR3 of standard LPS1175, equivalent to bars and grilles. Firearm protection to level FB4 of EN 1522/1523.

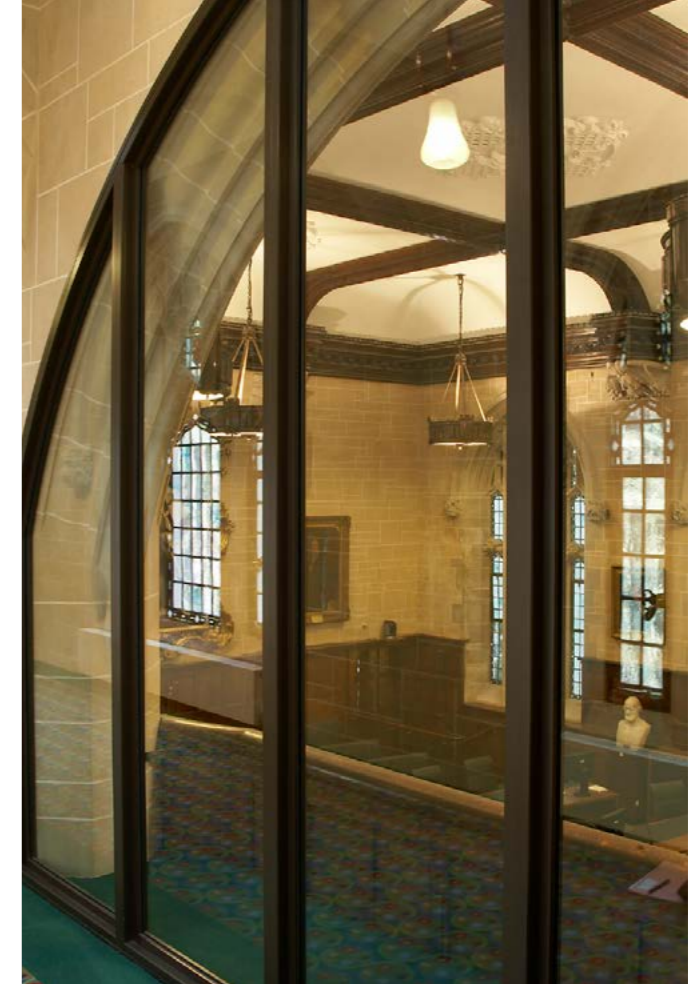

FEATURES

- Heavy duty framing system for maximum strength
- Glazed panels are attached with machine screws which permits occasional removal for cleaning and maintenance
- 30mm glass edge cover
- Fixings concealed within the frame
- Frames can be coupled vertically or horizontally

DIMENSIONS

Recommended maximum frame

Format	Height (mm)	Width (mm)
BLAST	3600	1800
INTRUDER	3200	1800
FIREARM	2500	1500

Minimum (all) (h)400mm x (w)400mm

Overall dimensions are subject to a risk assessment covering sash weight and window location

FRAME COLOUR

Stock finish is white HIPCA 9910 semi-gloss
Any standard powder paint, wood grain finish or anodised finish to order

OPTIONS

Glazing	9.5mm to 22mm
Frames	Curved head or jamb – minimum radius 1500mm Steel reinforcement to meet FB4 protection

Ironmongery

HANDLES AND FINGER PULLS

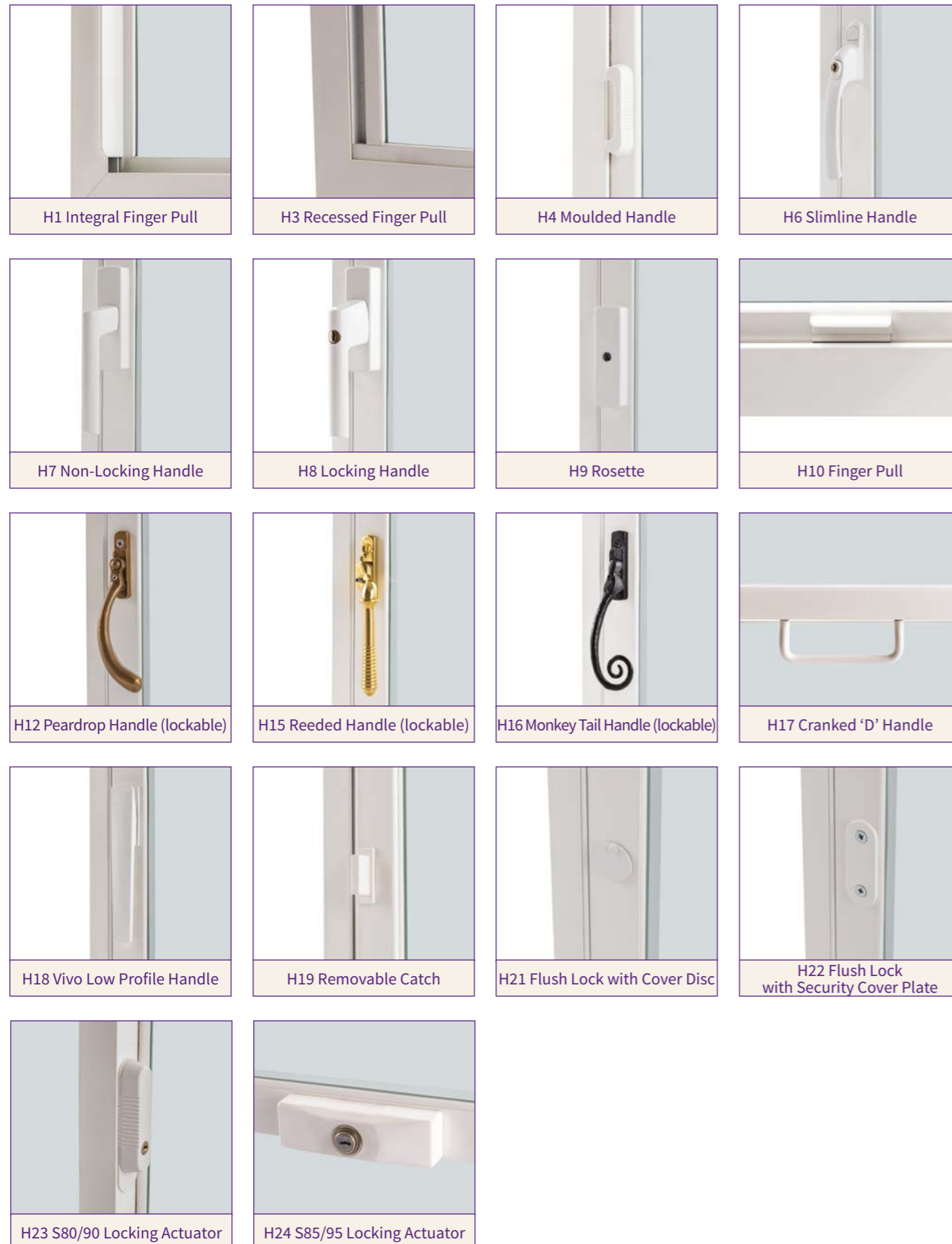

LOCKS AND CATCHES



FINISHES

Handles and Finger Pulls	Finish
H1 Integral Finger Pull	CM
H3 Recessed Finger Pull	CM
H4 Moulded Handle	CM
H6 Slimline Handle	WH, BL, GO, PC, SC
H7 Non-Locking Handle	CM
H8 Locking Handle	CM
H9 Rosette (Square Drive/Removable Key)	CM
H10 Finger Pull	CM
H12 Peardrop Handle (lockable)	BL, PB, PC, BRA
H15 Reeded Handle (lockable)	PB, PC, SC
H16 Monkey Tail Handle (lockable)	BL
H17 Cranked 'D' Handle	CM
H18 Vivo Low Profile Handle	CM, PC, SC, GO, DG
H19 Removable Catch	CM
H21 Flush Lock with Cover Disc	CM
H22 Flush Lock with Security Cover Plate	CM
H23 S80/90 Locking Actuator	CM
H24 S85/95 Locking Actuator	CM

Locks and catches	Finish
L1 Shoot Bolt	Internal – not seen
L2 Fitch Catch (lockable)	WH, BL, GO, PC, BS
L3 SBD Fitch Catch (2 per unit)	WH, BL, GO, PC, BS
L4 Plunge Lock	SI
L7 Spring Catch	W, SC
L11 Mini Camlock	SI
L12 Screwlock	WH, BL
L13 S10/20 Sliding Latch	CM
L24 S15/25 Sliding Latch	CM
L29 Sprung Restrictor Stay	Internal – not seen

Key to Finishes

BL – Black
 BRA – Brass
 BS – Brushed Steel
 CM – Colour to Match Frame*
 DG – Dark Grey
 GO – Gold
 PB – Polished Brass
 PC – Polished Chrome
 SC – Satin Chrome
 SI – Silver
 WH – White

* Closest match for moulded materials
 (not applicable for anodised finishes)

Fixing details

Selectaglaze secondary windows are designed with concealed fixings to present a clean appearance. Odd leg framing systems allow tolerances to be accommodated without the need for cover fillets to the internal face. Frames and associated timbers are purpose made to provide a tight fitting seal and so ensure highest performance.

When larger section timbers or sill extensions are required, these are decorated on exposed room side surfaces in a close match to the frame colour. Typical fixing details are illustrated.

STANDARD SQUARE REVEAL FIX

- 33mm x 15mm twice primed softwood ground bedded in acrylic sealant and fixed to structure
- Odd leg frame with applied sealant is conceal fixed to ground
- Local hidden packers take up opening tolerance
- Optional caulking joint between frame and wall allows finished decoration

Guidance

- Set back minimum 12mm from face of plastered reveals to avoid blowing plasterwork
- Fixings for hinged units must penetrate into structure
- Enlarged timber grounds required when:
 - openings are very irregular
 - access needed for remote blind controls
- Optional back fillet available to conceal packing

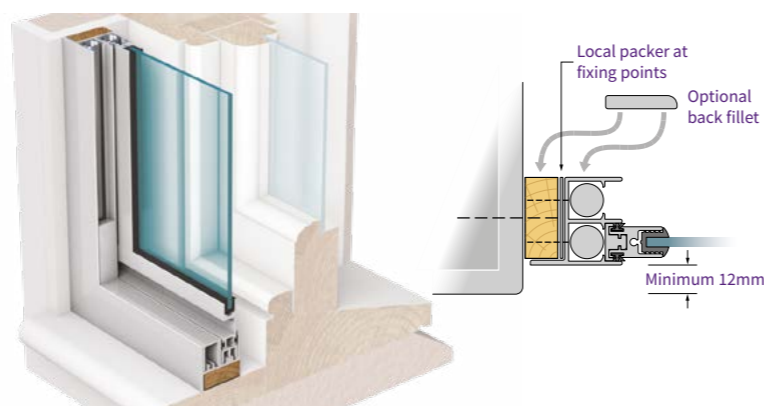

FACE FIX

- Softwood frame with minimum 38mm x 32mm section bedded in acrylic sealant and fixed to structure
- Optional moulding
- Odd leg frame with applied sealant is conceal fixed to timber

Guidance

- Suitable detail where:
 - no reveal exists
 - where clearance is needed for inward opening windows
- Remote blind controls and ventilators cannot normally be accommodated

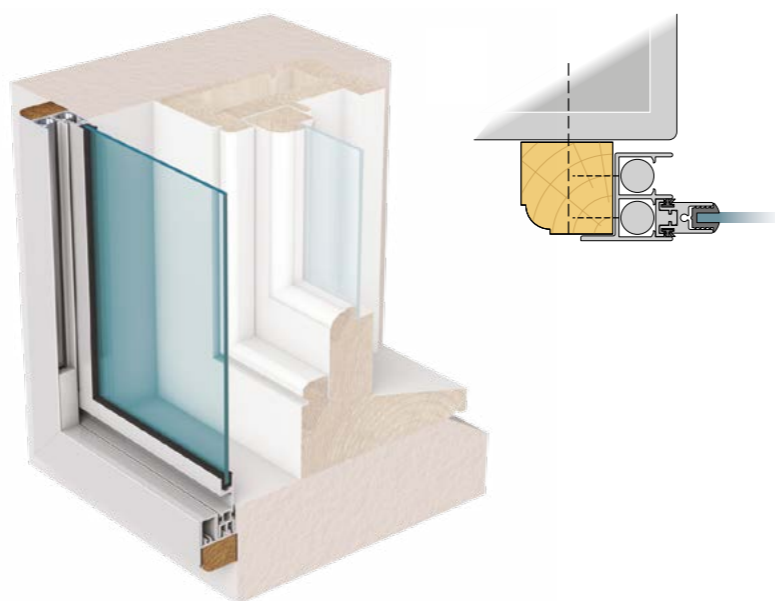

VENTILATORS

Approved Document F covers means of ventilation and applies to new build and major refurbishments. Ventilation is required to provide change of air and help reduce the damaging effects of condensation. It is normally sufficient to open internal secondary windows to provide this ventilation but sometimes permanent ventilation will be required using trickle ventilators in both the inner

and outer window – a minimum 5000mm² equivalent area in each Habitable rooms and 2500mm² equivalent area in each Wet room. These can be fitted within an enlarged timber sub-frame usually at the head of the secondary window. Properties being treated under statutory noise insulation schemes require acoustically dampened mechanical ventilation fitted through an external wall.

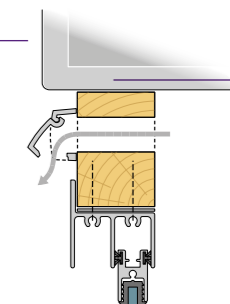

SPLAYED REVEAL FIX

- Softwood timber machined to match the splay
- Odd leg frame with applied sealant is conceal fixed to timber
- Local hidden packers take up opening tolerance

Guidance

- Set back minimum 12mm from face of plastered reveals to avoid blowing plasterwork
- When attaching to shutters ensure that these are securely fixed back and sealed beforehand
- Timber section can be sized to accommodate remote blind controls
- Optional back fillet available to conceal packing

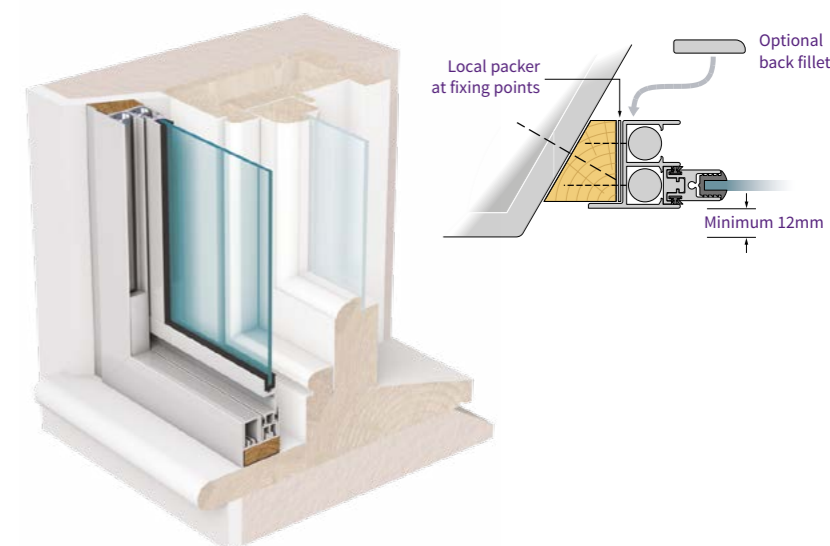

FLUSH BOX SASH

- Timber sized to provide a minimum 75mm clearance at meeting rail and fixed to box sash
- Optional moulding
- Odd leg frame with applied sealant is conceal fixed to timber

Guidance

- Minimum 75mm cavity applies to use of matching sash window system
- If a wider timber is specified the architrave can be resited to the face of the secondary window

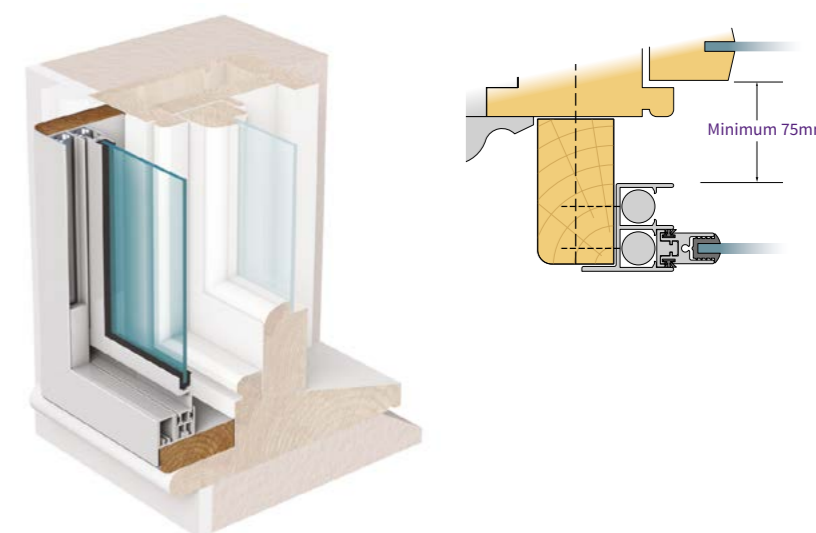

Coupling details

A range of versatile sections allows Series to be coupled together, either as a Transom (illustrated) when windows are stacked vertically or as a Mullion when they are coupled horizontally.

The 'H' feature on the face of the section holds the frame flange firmly in place ensuring a good seal and also acts to mask the effect of any shims needed during fixing.

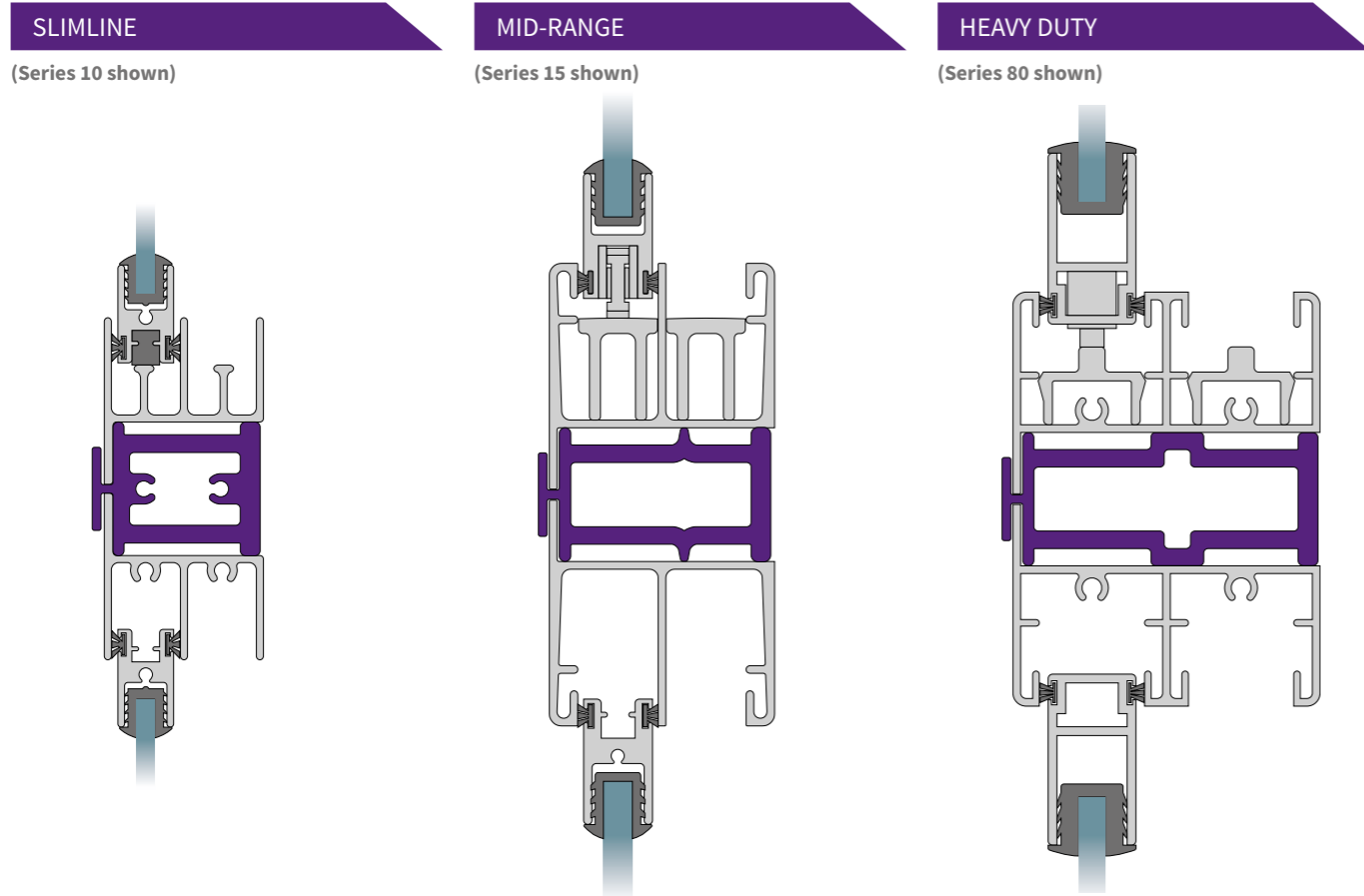

TRANSOM SUPPORT

- Guidance**
- Transom spans above 1.4m may require separate support
 - Factors will include the upper window
 - style
 - size
 - glazing

- Standard method**
- 25mm box section set behind interlock stile and bolted to transom.

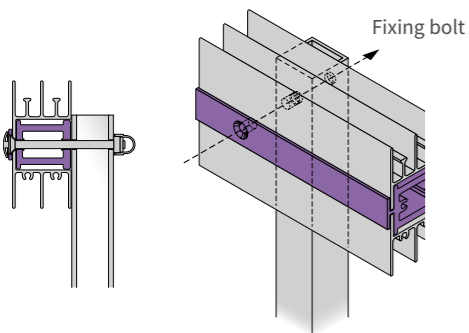

- Alternative method**
- 25mm flat bar hanger bolted to transom. This method is weight dependent.

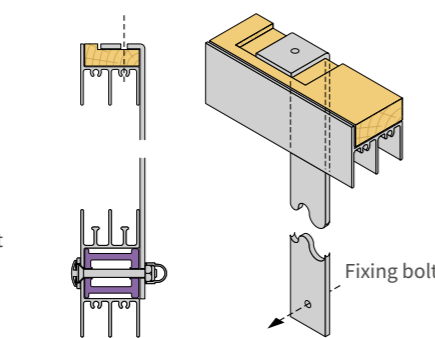

SHAPED COUPLING

- Patterned timber sections finished to complement frames
- Suitable for:
 - bay windows

Square Bay

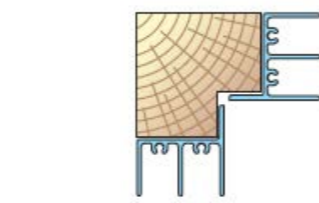

Angled Bay

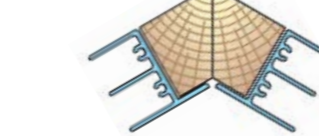

Performance tables

THERMAL - TYPICAL U-VALUES

Product	Timber primary + secondary unit 100mm cavity				Metal primary + secondary unit 100mm cavity			
	6mm clear float	6mm low-E	4-12-4 SU low-E and gas	24mm enhanced thermal sealed unit	6mm clear float	6mm low-E	4-12-4 SU low-E and gas	24mm enhanced thermal sealed unit
S10 HS	2.629	1.807			2.911	1.936		
S80 HS	2.640	1.810			2.920	1.940		
S85 HS	2.700	1.840			3.000	1.970		
S20 VS	2.617	1.802			2.897	1.930		
S60 VS	2.639	1.812			2.924	1.942		
S90 VS	2.615	1.801			2.894	1.929		
S95 VS	2.698	1.840			2.996	1.974		
S41 HC	2.581	1.785	1.627	1.27	2.852	1.910	1.731	1.34
S45 HC	2.576	1.782			2.846	1.908		
S50 HC	2.589	1.788	1.700	1.32	2.862	1.915	1.813	1.38
S30 LO	2.585	1.787			2.858	1.913		
S41 LO	2.581	1.785	1.627	1.27	2.852	1.910	1.731	1.34
S45 LO	2.576	1.782			2.846	1.908		
S40 FL	2.574	1.781	1.435	1.15	2.843	1.906	1.515	1.21
S46 FL	2.579	1.784			2.850	1.910		

These figures are calculated using modelling software by The Centre for Window and Cladding Technology (CWCT) at The University of Bath. All figures are in W/m²K.

- Assumptions**
1. The timber primary window has 6mm glass and a typical overall U-value of 4.71 W/m²K.
 2. The metal primary window has 6mm glass and a typical overall U-value of 5.7 W/m²K.
 3. The window size is 1480mm x 1230mm i.e. BFRC (British Fenestration Rating Council) size.

- Notes**
1. The depth of cavity has a small effect
 Example: Series 10 Horizontal Slider using low-e glass against a timber primary window
 50mm cavity = 1.737
 100mm cavity = 1.807
 200mm cavity = 1.883
 2. The proportion of aluminium to glass in the window has an effect
 Example: Series 50 DSHC using Low-e sealed units with Gas
 BRFC standard size: 1480 x 1230 = 1.927
 Large size: 3000 x 1500 = 1.733

Performance tables (continued)

ACOUSTIC – TYPICAL R_w dB VALUES WITH 150mm CAVITY

Primary glass thickness (mm)	Secondary glass thickness (mm)	S10 HS	S80 HS	S85 HS	S20 VS	S60 VS	S90 VS	S95 VS	S41 HC	S45 HC	S50 HC	S30 LO	S41 LO	S40 FL	S46 FL	S55 DFL
6	4mm toughened	45			45	46			47	47		44	47	47		
6	4mm float	45			45	46			47	47		44	47	47		
6	6mm	45	46		45	46	46		47	47	46	44	47	47	47	
6	6.4mm	45	46		45	46	46		47	47		44	47	47		
6	6.4mm stadip silence	46	47		46	47	47		48	48		45	48	48		
6	6.8mm	46	47		46	47	47		48	48		45	48	48		
6	6.8mm stadip silence	46	47		46	47	47		48	48		45	48	48		
6	7.5mm		47				46		48		47		48	48		46
6	8mm float	47	48		47	48	48		49	49		46	49	49		
6	8.8mm		48				48		49				49	49		
6	8.8mm stadip silence		48				48		49	48			49	49		
6	9.5mm		48	47			48	47	49		48		49	49		47
6	10mm		48				48		49				49	49		
6	10.8mm		49				48		50	49			50	50		
6	10.8mm stadip silence		49				48		50	49			50	50		
6	11.5mm		49	48			49	48	50		49		50	50		48
6	12mm		49				48		50				50	50		

A range of Selectaglaze products and specifications have been tested at the Taylor Woodrow Technology Centre. The results have then been interpreted by Hann Tucker Associates, consultants in Acoustics, to extrapolate and interpolate sound reduction values for the wider range.

Notes

R_w Correction Factors (based upon laboratory tested scenarios)

- Acoustic tiles on 3 sides with low spec glass +2dB
- Acoustic tiles on 3 sides with high spec glass +1dB
- Acoustic vent (4000 mm²) – open -2dB
- Trickle vent (4000 mm²) – open -3dB
- Trickle vent (8000 mm²) – open -5dB

The tested vent sizes predate the current Approved Document F which requires 5000mm² equivalent area in each Habitable room. The figures are therefore indicative of performance.

TYPICAL SECURITY RATINGS

Test Type	Test Standard	Rating Level	S10 HS	S15 HS	S80 HS	S85 HS	S20 VS	S25 VS	S90 VS	S95 VS	S41 HC	S45 HC	S50 HC	S40 FL	S42 FL	S46 FL	S43 DFL	S55 DFL	
Physical Attack	PAS 24: 2012 SBD	Single Level			■			■	■		■	■		■		■			
		SR1				■				■			■		■		■	■	
	LPS 1175	SR2				■				■			■		■		■	■	
		SR3																	■
Ballistic Attack	EN 1522	FB4 (Magnum handgun)																■	
Blast Mitigation	ISO 16933	EXV 45	■					■								■			
		EXV 33		■	■			■	■		■	■		■					
		EXV 25				■					■			■		■		■	■
		EXV 15												■					■
Fire Resistance	BS EN 1363-1/1364-1	30 minute integrity													■				

Notes

- PAS 24: 2012 Products are subjected to static loads on the frames up to 3KN followed by manual intervention using a range of tools but without breaking the glass.
- LPS 1175 security ratings are based on defined tool sets for each level, a maximum work time and a total period allowed which covers assessment, change of tools and rest (refer to www.redbooklive.com for more information).
- Products are blast tested against 100Kg TNT equivalent with targets set at prescribed distances:
EXV45 – 45M stand off
EXV33 – 33M stand off
EXV25 – 25M stand off
EXV15 – 15M stand off
- FB4 provides protection against a .44 Magnum Hand Gun

Security rating	Tool category	Maximum work time (mins)	Maximum test duration (mins)
SR1	A	1	10
SR2	B	3	15
SR3	C	5	20



selectaglaze
Secondary Glazing

Selectaglaze Ltd., Alban Park, Hatfield Road, St. Albans AL4 0JJ
T 01727 837271 F 01727 844053
E enquiries@selectaglaze.co.uk
www.selectaglaze.co.uk